

ERCIM NEWS

Special theme:

Educational Technology



Editorial Information

ERCIM News is the magazine of ERCIM. Published quarterly, it reports on joint actions of the ERCIM partners, and aims to reflect the contribution made by ERCIM to the European Community in Information Technology and Applied Mathematics. Through short articles and news items, it provides a forum for the exchange of information between the institutes and also with the wider scientific community. This issue has a circulation of about 6,000 printed copies and is also available online.

ERCIM News is published by ERCIM EEIG
BP 93, F-06902 Sophia Antipolis Cedex, France
+33 4 9238 5010, contact@ercim.eu
Director: Philipp Hoschka, ISSN 0926-4981

Contributions

Contributions should be submitted to the local editor of your country

Copyright notice

All authors, as identified in each article, retain copyright of their work. ERCIM News is licensed under a Creative Commons Attribution 4.0 International License (CC-BY).

Advertising

For current advertising rates and conditions, see
<https://ercim-news.ercim.eu/> or contact peter.kunz@ercim.eu

ERCIM News online edition: ercim-news.ercim.eu/

Next issue:

April 2020: *The Climate Challenge*

Subscription

Subscribe to ERCIM News by sending an email to en-subscriptions@ercim.eu

Editorial Board:

Central editor:
Peter Kunz, ERCIM office (peter.kunz@ercim.eu)

Local Editors:

Austria: Erwin Schoitsch (erwin.schoitsch@ait.ac.at)
Cyprus: Georgia Kapitsaki (gkapi@cs.ucy.ac.cy)
France: Christine Azevedo Coste (christine.azevedo@inria.fr)
Germany: Alexander Nouak (alexander.nouak@iuk.fraunhofer.de)
Greece: Lida Harami (lida@ics.forth.gr),
Athanasios Kalogeras (kalogeras@isi.gr)
Hungary: Andras Benczur (benczur@info.ilab.sztaki.hu)
Italy: Maurice ter Beek (maurice.terbeek@isti.cnr.it)
Luxembourg: Thomas Tamisier (thomas.tamisier@list.lu)
Norway: Monica Divitini (divitini@ntnu.no),
Are Magnus Bruaset (arem@simula.no)
Poland: Hung Son Nguyen (son@mimuw.edu.pl)
Portugal: José Borbinha (jlb@ist.utl.pt)
Sweden: Maria Rudenschöld (maria.rudenschold@ri.se)
Switzerland: Harry Rudin (hrudin@smile.ch)
The Netherlands: Annette Kik (Annette.Kik@cw.nl)
W3C: Marie-Claire Forgue (mcf@w3.org)

Cover illustration: source: Shutterstock.

SPECIAL THEME

The special theme “Educational Technology” has been coordinated by Vassilis Katsouros (Athena Research and Innovation Centre) and Martin Hachet (Inria)

Introduction to the special theme

4 Educational Technology

by Vassilis Katsouros (Athena Research and Innovation Centre) and Martin Hachet (Inria)

6 A Logic-Based Affective Tutoring System

by Achilles Dougalis and Dimitris Plexousakis (ICS-FORTH)

7 Learning Introductory Programming with Smart Learning Environment

by Boban Vesin (University of South-Eastern Norway), Katerina Mangaroska and Michail Giannakos (NTNU)

9 Interoperable Education Infrastructures: A Middleware that Brings Together Adaptive, Social and Virtual Learning Technologies

by Christopher Krauss and Manfred Hauswirth (Fraunhofer FOKUS)

10 Fraunhofer IAIS IoT Programming Language NEPO® in the Open Roberta® Lab

by Thorsten Leimbach (Fraunhofer IAIS), Daria Tomala (Fraunhofer IAIS)

12 Modelling Student Learning and Forgetting for Optimally Scheduling Skill Review

by Benoît Choffin (LRI), Fabrice Popineau (LRI) and Yolaine Bourda (LRI)

13 Ontology-based Learning Analytics in Medicine

by Fabrice Jouanot (Univ. Grenoble Alpes), Olivier Palombi (Univ. Grenoble Alpes, CHU de Grenoble) and Marie-Christine Rousset (Univ. Grenoble Alpes, IUF)

15 Blockchain for Education: Lifelong Learning Passport

by Wolfgang Prinz, Sabine Kolvenbach and Rudolf Ruland (Fraunhofer FIT)

16 An Educational Platform for Logic-based Reasoning

by Dimitrios Arampatzis (FORTH-ICS), Maria Doulgeraki (FORTH-ICS), Michail Giannoulis (Univ. of Crete), Evropi Stefanidi (FORTH-ICS), and Theodore Patkos (FORTH-ICS)

17 Authoring Game-Based Learning Activities that are Manageable by Teachers

by Pedro Cardoso (FEUP/ FBAUP and INESC TEC), Leonel Morgado (Universidade Aberta and INESC TEC), and António Coelho (FEUP and INESC TEC)

19 LudiMoodle: Adaptive Gamification to Improve Learner Motivation

by Élise Lavoué (Université Jean Moulin Lyon 3)

20 Can Tangible Robots Support Children in Learning Handwriting?

by Arzu Guneyesu Ozgur, Barbara Bruno, Thibault Asselborn and Pierre Dillenbourg (EPFL)

22 “You Tell, I Do, and We Swap until we Connect All the Gold Mines!”

by Jauwairia Nasir, Utku Norman, Barbara Bruno and Pierre Dillenbourg (EPFL)

23 Gestures in Tangible User Interfaces

by Dimitra Anastasiou and Eric Ras (Luxembourg Institute of Science and Technology)

25 Kniwwelino: A Microcontroller-based Platform Introducing Children to Programming and Electronics

by Valérie Maquil and Christian Moll (Luxembourg Institute of Science and Technology)

26 Virtual Simulation Environment for Medical Training

by Thomas Luiz, Dieter Lerner, Dominik Schnier (Fraunhofer IESE)

27 Mixed Reality and Wearables in Industrial Training

by Ralf Klamma (RWTH Aachen University), István Koren (RWTH Aachen University) and Matthias Jarke (Fraunhofer FIT and RWTH Aachen University)

29 Personalized Interactive Edutainment in Extended Reality (XR) Laboratories

by Aris S. Lalos (ISI, ATHENA R.C.), Chairi Kiourt (ILSP, ATHENA R.C.), Dimitrios Kalles (Hellenic Open University) and Athanasios Kalogeras (ISI, ATHENA R.C.)

30 Music in Education through Technology

by Maximos Kaliakatsos-Papakostas, Kosmas Kritsis, Vassilis Katsouros (Institute for Language and Speech Processing, Athena Research and Innovation Centre)

32 Dance Education and Digital Technologies

by Katerina El Raheb and Yannis Ioannidis (“Athena” Research and Innovation Center and National and Kapodistrian University of Athens)

33 Intelligent Classroom: Materialising the Vision of Ambient Intelligence for Education

by Asterios Leonidis, Maria Korozi, Margherita Antona and Constantine Stephanidis (FORTH-ICS)

35 Innovative Monitoring of Learning Habits and Motivation in Undergraduate Mathematics Education

by Brigitta Szilágyi (Budapest University of Technology and Economics), Szabolcs Berezvai (Budapest University of Technology and Economics) and Daniel Horvath (EduBase Online Ltd.)

36 When a Master of Sciences on EdTech becomes an International Community

by Margarida Romero, Saint-Clair Lefèvre (UCA, INSPE, LINE) and Thierry Viéville (Inria)

38 DE-TEL - A European initiative for Doctoral Education in Technology-Enhanced Learning

by Mikhail Fominykh and Ekaterina Prasolova-Førland (NTNU)

39 Ethical Teaching Analytics in a Context-Aware Classroom: A Manifesto

by Romain Laurent (Univ. Grenoble Alpes/LaRAC), Dominique Vaufreydaz (Univ. Grenoble Alpes, CNRS, Inria, Grenoble INP, LIG), and Philippe Dessus (Univ. Grenoble Alpes/LaRAC)

RESEARCH AND INNOVATION

41 KANDINSKY Patterns: A Swiss-Knife for the Study of Explainable AI

by Andreas Holzinger (Medical University Graz and Alberta Machine Intelligence Institute Edmonton, Canada), Peter Kieseberg (University of Applied Sciences, St.Poelten) and Heimo Müller (Medical University Graz)

43 Building Reliable Storage Systems

by Ilias Iliadis (IBM Research – Zurich Laboratory)

45 Browse, Visualise, Analyse EU Procurement Data

by Ahmet Soylu and Till C. Lech (SINTEF)

46 More on 5G: Millimetre-Waves

by Gregor Dürrenberger (FSM) and Harry Rudin

ANNOUNCEMENTS

48 FMICS 2020: 25th International Conference on Formal Methods for Industrial Critical Systems

48 ERCIM Membership

49 ERCIM “Alain Bensoussan” Fellowship Programme

50 Dagstuhl Seminars and Perspectives Workshops

50 Tim Berners-Lee Launches Global Action Plan to Prevent “Digital Dystopia”

50 HORIZON 2020 Project Management

51 W3Cx Introduction to Web Accessibility – New Online Course

51 HAL is Opening Up to Software

51 David Chaum and Guido van Rossum awarded Dijkstra Fellowship

Introduction to the Special Theme

Educational Technology

by Vassilis Katsouros (Athena Research and Innovation Centre) and Martin Hachet (Inria)

This special theme addresses the state of the art in educational technologies, “EdTech”, illustrating the range of scientific fields and challenges faced by the research community when it comes to integrating tools and systems that apply to real-life learning situations.

Education, either formal or informal, is a key driver for the future of our societies; it fosters personal fulfilment and development, social inclusion and active citizenship, as well as generating innovation and economic activities. Right now, digital tools are opening up promising new opportunities to take education to the next level.

Digital tools in education go far beyond the introduction of computers to schools. The introduction of computers to children can even have counter-productive effects on their ability to acquire knowledge and skills. It is vital that we take a holistic approach to educational technologies, where the learner and the teacher stay at the centre of the loop.

As a consequence, modern educational technologies are emerging from multidisciplinary research, building notably on advances in pedagogical and learning theories, educational psychology, interaction technologies and artificial intelligence. This special issue illustrates the richness of the current research in EdTech, where human factors, software and hardware technologies, and even organisational and ethical considerations all contribute towards building tomorrow's education, either in formal, informal, or professional learning contexts.

Intelligent tutoring systems that adapt learning content to the individual's progress are becoming more sophisticated with the ability to consider the learner's emotions and learning style, as illustrated by Dougalis and Plexousakis (p. 6). Vesin, Mangaroska and Giannakos (p. 7) present a personalised and adaptive tutoring system covering a complex interplay of content, tasks, instructions, social dynamics and learning analytics to teach introductory programming to university students. A common learning middleware in the article by

Krauss and Hauswirth (p. 9) facilitates content from different learning management systems and enriches it with innovative technologies such as gamification, social learning, virtual reality and learning recommenders. Leimbach and Tomala (p. 10) propose an integrated programming environment combined with a graphical programming language that allows learners to code a wide range of robotic systems, promoting STEM education to young children.

Choffin, Popineau and Bourda (p. 12) suggest modelling student learning and forgetting for optimally scheduling distributed practice of skills, and Jouanot, Palombi and Rousset (p. 13) propose an ontology-based method for making learning analytics transparent and explainable using a query language that allows users to express specific needs of data exploration and analysis. As certificates play an important role in education, and individual learning records become essential for people's professional careers, the blockchain for education platform (Prinz, Kolvenbach and Ruland, p. 15) introduces a secure and intuitive solution for issuing, sharing, and validating educational certificates.

Motivation is an essential lever for engaging students in learning processes. Hence, several authors have explored how motivation can be maintained and enhanced through gamification mechanisms. This is notably the case for EduBAI (Arampatzis et al., p. 16) whose goal is to help build reasoning by leaning on a basketball game rationale. In the BEACONING project presented by Cardoso, Morgado and Coelho (p. 17), gamification is used to make lesson plans more fluid. The LudiMoodle project, described by Lavoué (p. 19), similarly evaluates the impact of gamification on motivation.

Motivation and engagement can also be encouraged by physically involving the learner in the task. Tangible, hands-on activities can help build knowledge, and enhance collaborative work and social interaction. Hence, compared with purely digital approaches, hybrid approaches that mix

physical and digital components have great potential. The CHILI Lab at EPFL explores approaches based on robots to support handwriting (Ozgur et al., p. 20) or to accompany a collaborative problem-solving task (Nasir et al. p.22). Problem-solving is also the topic of the article by Anastasiou and Ras (p. 23) where tangible user interfaces are combined with 2D and 3D gestures. In Kniwwelino (Maquil and Moll, p. 25), the hands-on activities are supported by a combination of a visual programming language and a physical microcontroller equipped with sensors and displays.

In the EPICSAVE project (Luiz, Lerner and Schnier, p. 26), an immersive room-scaled multi-user 3D virtual simulation environment for medical training scenarios enabling realistic and sustainable training experiences is presented. The WEKIT project (Klamma, Koren and Jarke, p. 27) has developed an industrial training platform combining sensor technologies with mixed and augmented reality for on-the-job training. Virtual, augmented and mixed reality is also used in the project described by Lalos et al. (p. 29) to provide an educational platform for virtual scientific laboratories for STEM education. Kaliakatsos-Papakostas, Kritsis and Katsouros (p. 30) introduce iMusciCA, a web-based workbench that integrates advanced core enabling technologies, including 3D design and printing of musical instruments, body tracking sensors for gesture recognition, interactive pens and tablets as well as sound generation and processing tools for STEA(rts)M education. The WhoLoDancE project (El Raheb and Ioannidis p. 32) has developed web-based tools for the analysis, segmentation, annotation and blending of dance movements as well as interactive experiences that integrate augmented and mixed reality, sonification of movement and visualisation of the human body and movement in different avatars and environments. Leonidis et al. (p. 33), present a student-oriented and educator-friendly intelligent classroom that integrates several features, such as synchronous or event-based communication, identification of learners' behaviour, etc. and attractive, situational environments for learning.

In addition to these research activities and technological developments, various initiatives aim at organising and teaching EdTech. For example, the Edubase Online Platform (Szilágyi and Berezhvai,

p. 35) is a learning-management system (LMS) that provides numerous teaching and testing interfaces. Romero, Lefèvre and Viéville (p. 36) present the SmartEdTech Master program. It is dedicated to the teaching of, and with, educational technology. Similarly, at a doctoral level, the DE-TEL program (Fominykh and Prasolova-Førland, p. 38) is a European initiative dedicated to a new form of technology-enhanced learning. For all these research works and initiatives in EdTech, ethics should remain a central pillar of the upcoming generation of teaching tools and approaches. This is the focus of a manifesto presented by Laurent, Vaufreydaz and Dessus (p. 39).

The articles in this special theme give a broad overview of the current state of research and applications and insight into ongoing projects in the educational technologies field.

Digital enhanced learning is also addressed by the recent DEL4ALL (Digital enhanced learning for All) project [L1], funded by the European Union. With a forward-looking perspective, it analyses best-practice, success stories as well as challenges and opportunities offered by the increasing adoption of technologies, such as blockchain, artificial intelligence and others. DEL4All is expected to provide a basis for future research directions and policy recommendations to enable the transition from Horizon 2020 to Horizon Europe funded research and innovation projects in the area of digital enhanced learning.

Link:
[L1] <https://www.del4all.eu/>

Please contact:
Vassilis Katsouros
Athena Research and Innovation Centre, Greece
vsk@athenarc.gr

Martin Hachet
Inria, France
martin.hachet@inria.fr

A Logic-Based Affective Tutoring System

by Achilles Dougalis and Dimitris Plexousakis (ICS-FORTH)

In science fiction, artificial agents are portrayed as being capable of interacting with and helping humans. This aid could take the form of holding intelligent conversations and even acting as teachers and coaches. Some progress has been made in this direction in real life. Indeed, systems utilising intelligent agents, such as duolingo™, have proven capable of acting as personal tutors. These “intelligent tutoring systems” (ITS) emulate a human tutor by using AI techniques to adapt instructions and teaching according to each individual learner’s background and progress but also guide the learner through an exercise by providing hints and feedback.

These systems are results of a combination of multiple disciplines, such as computer science, cognitive psychology, human-robot interaction and educational research. Some advantages of ITS are that they are location-independent, easily accessible, and offer great flexibility, allowing students to learn at their own pace and not to have to rely on rigid classroom schedules.

Researchers have found that a learning session can be improved if the teacher is empathetic to the emotions of the learner. Such improvements could take the form of an ITS offering help when it detects that the learner is confused, or by offering the learner motivating remarks when it detects boredom. ITS systems that make use of emotions are known as affective tutoring systems (ATS). ATS combine tutoring strategies and emotion sensing techniques into a single system. Also, evaluations have shown that they can contribute positively to the user’s learning experience [1].

A disadvantage of these systems is that they are designed for teaching a specific subject to specific users, making reusability difficult or even impossible. Moreover, the more diverse and complicated a course is, the more difficult it is to manage it. In other words, there is a need for a universal, well-defined structure in order to facilitate the design of ITS. Fortunately, similar problems in different domains have been dealt with successfully using a knowledge representation and reasoning approach. Such approaches use declarative logic and logical formalisms known as action languages in order to formalise the problem and use AI techniques, such as projection and planning, in order to solve it. ITS that make use of this approach already exist and are known as cognitive tutoring systems. However, these systems are always modelled around a specific course or problem, they don’t take

any preferences of the user into account and none of them have been used for affective input. In order to tackle the user’s preference problem, researchers have created the field of “adaptive learning systems”. These systems use machine learning techniques in order to adapt the content of a given course according to the preferences of their current user. However, these systems do not offer feedback to the user (emotional or cognitive) as

they are mainly concerned about the course’s presentation.

In order to address these limitations of both fields, we have built AFFLOG, an adaptive cognitive affective tutoring system that uses answer set programming and the event calculus action language [2] in order to represent the various components and actions of an ATS, and perform reasoning tasks such as planning for creating a course suitable

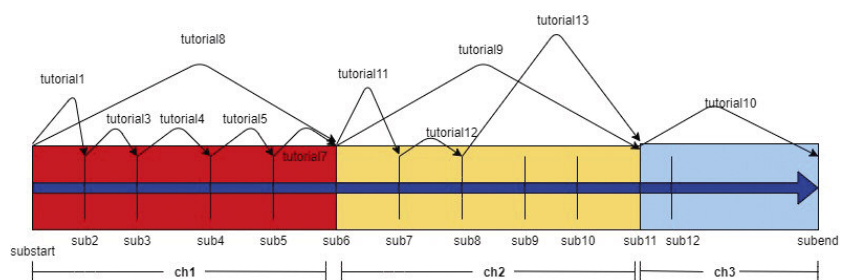

Figure 1: A course as a directed graph. Each subchapter is depicted as a node, with one or more tutorials represented as vectors linking it with other nodes. A chapter can be traversed either by one tutorial (e.g. tutorial8 for chapter1) or by a selection of smaller tutorials.

Emotional State	Light response	Medium response	Drastic response
neutral	none	none	none
flow	offer praise	suggest extra tutorials	none
confusion	offer encouragement	select easier tutorials	offer short break
joy	offer praise	none	none
surprise	none	select extra tutorials	none
frustration	offer encouragement	select easier or shorter tutorials	terminate session
boredom	offer encouragement	select shorter tutorials, change modality	none

Figure 2: Emotional Strategies according to the user’s current emotion.

to the current user, as well as offering the tools to create a new course from scratch. The main contributions of this work are:

- *Course representation*: We represent a course and its chapters in such a way that it can be effectively used by our system while also providing the author of the course with flexibility in terms of which modalities to use and also the design, structure and size of the course.
- *User representation*: Which parts of a specific course the user has learned, his/her preferred learning styles, as well as his/her emotional state regarding a course or a part of it.
- The integration of *emotions* and the user's learning style in the tutor's decision making process (Figure 2).

We use the term “tutorial” to describe the main building block for a course. A tutorial can be plain text, a picture, an audio file or a video file. Important semantic properties of a tutorial written in ASP include the subchapters that denote its beginning and end, as well as its modality, relative difficulty, its duration, and how suitable it is for the cur-

rent user according to his/her learning style. A “test” is the method the system uses in order to understand whether the user understood a part of the course.

A “course” is the material that the tutor uses to teach in one or more “sessions”. It is essentially a collection of tutorials and tests that are presented to the user. Each course consists of a number of “chapters” and each chapter consists of a number of “subchapters”. Subchapters are traversed using tutorials and can be described as nodes in a graph where the tutorials act as the vectors (Figure 2). Once the tutorials that comprise a chapter have been presented to the user, the tutor presents him/her with a test to determine whether the user understood the chapter. If the user passes the test, the tutor assumes that the user understood the chapter and proceeds to the next chapter. If not, the tutor assumes that the user has not understood one or more of the tutorials of the particular chapter, but since it cannot differentiate between which tutorial was misunderstood and which not, all the tutorials of that chapter are labelled as wrong. Consequently, the course must be modified using “plan-

ning” by replacing the wrong tutorials with unused tutorials for that chapter. When all the chapters are completed and all the tutorials are correct, the course has been completed successfully.

The work here represents a part of a PhD in emotional adaptive tutoring systems. Future work includes system evaluations, linking the system with the semantic web via the RDF language, and using machine learning methods to offer more personalised tutoring.

References:

- [1] B. Kort, R. Reilly, R. W. Picard: “An affective model of interplay between emotions and learning: Reengineering educational pedagogy-building a learning companion, 2001.”
- [2] M. Sergot, R. Kowalski: “A logic-based calculus of events”, *New Generation Computing* 4.1 (1985): 67-95.

Please contact:

Achilles Dougalis
FORTH-ICS, Greece
achil@ics.forth.gr

Learning Introductory Programming with Smart Learning Environment

by Boban Vesin (University of South-Eastern Norway), Katerina Mangaroska and Michail Giannakos (NTNU)

Programming Tutoring System (ProTuS) is an adaptive learning system developed to support introductory programming. ProTuS utilises a cross-platform architecture that aggregates and harmonises learner analytics coming from different systems and quantifies learners' performance through a set of indicators. ProTuS has been successfully used within universities to support teaching and learning.

Programming tutoring system

ProTuS [L1] was developed in the Learner-Computer Interaction lab [L2] at the Norwegian University of Science and Technology (NTNU), in cooperation with the University of South-Eastern Norway (USN). The system represents an effort to develop an adaptive and interactive environment that provides personalised learning to students (Figure 1) [1]. ProTuS covers a complex interplay of learning resources, tasks, instructions, social dynamics, interactions, and learning analytics aimed at helping students to learn introductory programming [2]. The system has been utilised at several universities for over a decade [3].

The current version of ProTuS includes interactive learning resources from various content providers, developed at several universities from Norway, USA and Canada. In addition, the system offers adaptive features based on content recommendation, automatic assessment and grading.

Interactive learning content

The interactive learning content (i.e., resources) included in the system comprises four types of activity that support individual work. Students can practice and learn programming through the following learning resources [2]:

Explanations. ProTuS contains reading content (i.e., tutorials) on 15 topics that

are aligned with the curriculum presented in the introduction to Java course. The objective behind the reading content is to allow students to leverage on their background knowledge on procedural programming (normally taught via Python) and progress with object-oriented programming (OOP). To do so, the content provides a comparison of the syntax and the basic concepts in Python (procedural) and Java (OOP).

Interactive examples. For each of the proposed topics, the students have the chance to explore different examples, called Program Construction EXamples (PCEX). Each PCEX content starts with

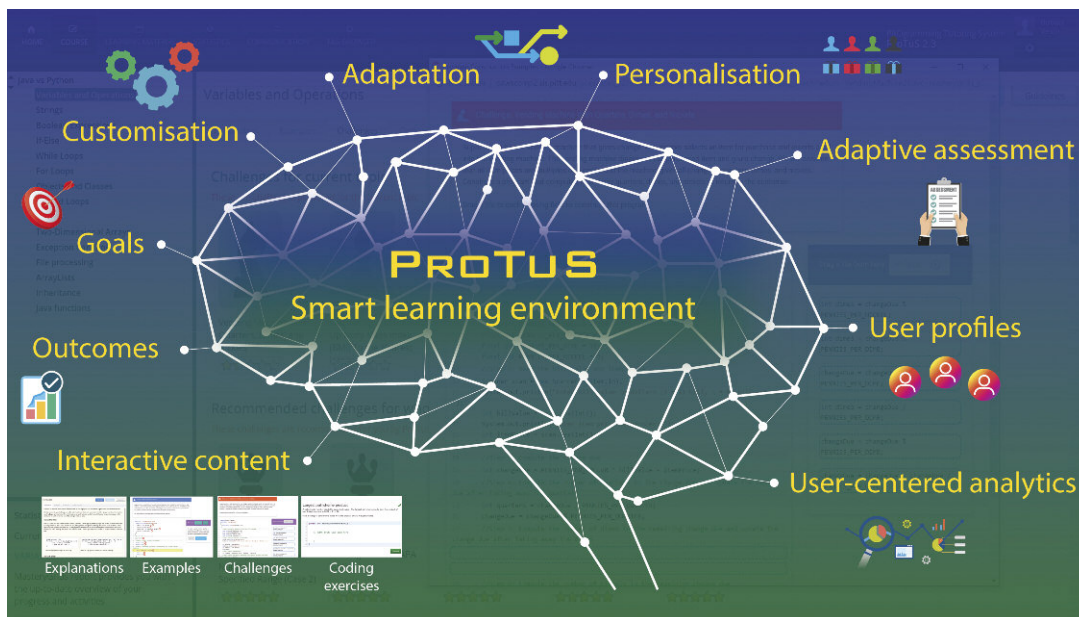

Figure 1:
Personalised learning
in ProTuS.

a worked-out example with explanation of how to write a code for a particular problem. The explanations (that are hidden until a student clicks on the lines of interest) are available for almost all lines in the example and they focus on why students need to write a code in a certain way or why certain programming constructs are used in the code.

Interactive challenges. To allow a seamless connection between theory and practice, as well as give students the possibility to try out the given examples, we present a challenge after each example. This allows students to solve one or more challenges related to the example that they previously viewed.

Coding exercises. This is a type of smart content that requires students to write code or complete a given code to achieve a certain goal. Each coding exercise has a problem description and a baseline code. When students submit their code, it is tested against a set of predefined unit tests and the student receives automated feedback on whether the tests were passed or not.

Interactive examples and challenges (Mastery Grids, PSEX) were developed at the University of Pittsburgh, and coding exercises (PCRS) at the University of Toronto [2].

Scaling up research efforts to support introductory programming

As a cross-platform architecture, ProTuS aggregates and harmonises learner-generated data from several sys-

tems into a set of meaningful indicators. Thus, it acts as a learning eco-system that leverages on various learning analytics to enhance personalised and adaptive learning. To address barriers hindering the usefulness and efficiency of an adaptive learning system, we examined ProTuS usability and evaluated its cross-platform learning analytics capacities to support personalised and adaptive learning [1]. The system has been tested in different universities throughout Norway and other European countries, with the results indicating that it shows promise for supporting introductory programming.

In the future, the authors plan to further develop the learning analytics component of ProTuS and provide more learner-centred visualisations and cross-analytics (e.g., data coming from assignments, project-work, course grading, and third-party software) [2]. Furthermore, the overall goal is to investigate how analytics derived from various sources can help us to construct efficient teaching strategies and support online and blended teaching and learning of introductory programming.

This project is a product of a research collaboration between NTNU and USN, receiving funding from Norwegian Agency for International Cooperation and Quality Enhancement in Higher Education (DIG-P44/2019), the Norwegian Research Council (255129/H20) and NTNU's Excellent Education program (NTNU Toppundervisning).

Links:

[L1] <https://protus.idi.ntnu.no/>

[L2] <https://lci.idi.ntnu.no/>

References:

- [1] B. Vesin, K. Mangaroska, M. Giannakos: "Learning in smart environments: user-centered design and analytics of an adaptive learning system," Smart Learn. Environ.
- [2] K. Mangaroska, B. Vesin, and M. Giannakos, "Cross-platform analytics: A step towards personalization and adaptation in education," LAK
- [3] A. Klačnja-Milićević, B. Vesin, and M. Ivanović, "Social tagging strategy for enhancing e-learning experience," C&E

Please contact:

Boban Vesin
University of South-Eastern Norway,
Norway
boban.vesin@usn.no

Interoperable Education Infrastructures: A Middleware that Brings Together Adaptive, Social and Virtual Learning Technologies

by Christopher Krauss and Manfred Hauswirth (Fraunhofer FOKUS)

What should a course provider do if all course content, which is stored in Moodle, needs to be migrated to a new learning management system? How could a provider easily use advanced technologies like learning analytics, learning recommender systems or virtual learning to create a compelling learning experience? How can a provider incorporate the content of another provider into an existing course? To address such questions, we developed the Common Learning Middleware in a joint project with several Fraunhofer institutes trying to solve these typical challenges facing educational institutions.

A wide range of technological components support or facilitate many successful approaches in the field of education, such as blended learning or flipped classroom learning. Learning analytics and educational recommender systems are based on statistical models and artificial intelligence; gamification and social- and peer-learning require appropriate backend services; learning content and media of these systems are typically hosted on different servers; and virtual and augmented reality used in educational systems require specialised hardware or software. Many promising approaches are being developed as isolated solutions, which individually are quite successful, but would only reach their full potential when used jointly. Together with the Fraunhofer Academy, Fraunhofer FOKUS is coordinating a research project that seeks to integrate isolated solutions with each other through a middleware component.

The Common Learning Middleware [L1] is based on open standards and specifications for educational technologies, including standardised interface definitions [L2], metadata specifications

for content structures [L3], learning objects [L4], and quizzes [L5], and standards for persisting activity data [L6]. Figure 1 shows the overall architecture of the Common Learning Middleware. In the underlying conceptual design, every element that can be integrated into the learning context, be it a text, image, video, dashboard or virtual reality, is abstracted as a tool. The different servers act as tool providers and can publish and subscribe their offers to the middleware. From there, the user interfaces, such as traditional learning management systems (e.g., Moodle or ILIAS) or advanced learning applications, can access the tools through standardised interfaces. The middleware verifies the roles and rights of the requesting users via its own user enrolment system for each access. In addition, existing user management systems can be connected to the middleware to enable cross-system logins. This enables the most diverse learning scenarios, which can be very well tailored to the respective learning context, without requiring programming skills of the content creator. To showcase our system, we give a few example sce-

narios, which were realised on the basis of individual solutions.

Together with the institutes Fraunhofer FIT and Fraunhofer IML, we have created a learning offer for the field of data science in which the learning content from the databases of several ILIAS platforms is presented in a self-developed learning portal from an external service provider. The portal also offers programming exercises (as individual Jupyter notebooks) after each major learning unit. Course participants can communicate via a tool provided by a start-up's innovative social learning platform. In another case, together with Fraunhofer IOSB and Fraunhofer FIT, we combined various tools for the cyber security domain. It merges online learning content from ILIAS and Open edX learning platforms with interactive learning applications developed by an external service provider into a single offering. In addition, the learned theories can be practically applied in the serious virtual reality game Lost Earth 2307 [1], in which the learner has to solve various security-relevant missions in a future scenario. The game is seamlessly loaded into the platform. The middleware is also utilised for university courses in computer science [2]. And in a parallel project, we even used these interfaces to link six different educational institutes, which normally have little contact, from the fields of crafts, computer science and general school education. This created synergies between the institutes on the basis of content and technology. On the one hand, courses on bookkeeping and accounting only had to be developed once and could be utilised by all institutions in their respective learning platforms. On the other hand, more advanced components, such as learning

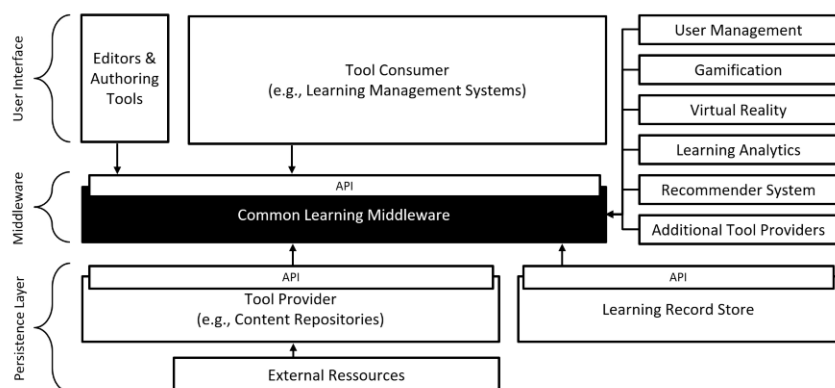

Figure 1: Simplified architecture of a learning infrastructure based on the Common Learning Middleware.

analytics, gamification, learning paths and a learning recommender system, were realised as tools and offered for the respective courses via the middleware.

Our recommender system [3] is a special tool provider that plays a central role, which focuses on determining “learning needs”. These are numerical values that represent the relevance of the corresponding content to each individual course participant. The higher the individual’s learning need for a topic, the more important it is that the learner should work on it. The learning platform loads the recommendation tool, which presents the content recommendations for the most relevant topics in order to make the learning process more efficient and effective. The recommender takes into account information that concerns the learning content itself. This includes, for example, data on whether certain content is relevant for exams or whether a lecture is about to take place. At the same time, information collected through direct user interaction is also included. For example, whether the participant has already edited all the underlying content, how the participant self-assesses in the subject area, how he or she has performed in exercises or how much of the content has already been viewed with the platform and for how long. A distinctive feature of the recommender

system is the “forgetting effect”, which provides information on whether the content was supposedly forgotten again based on the type of media, its scope and complexity as well as the time elapsed since the last learning. The users of the platform then see general and thematic recommendations in categories such as: “With these topics you can prepare for the next lecture.”, “You haven’t done so well in these exercises yet.” or “You might have forgotten this already.”

The Common Learning Middleware makes it possible to combine the most diverse educational technologies without having to forego content protection and rights management. Content from different learning management systems, such as Moodle, ILIAS or open edX, can easily be merged via a common interface definition and enriched with innovative technologies, such as learning analytics, gamification, social learning, virtual reality or learning recommender systems. Various institutions have already tested this middleware and Fraunhofer is successfully using it in several of its courses, such as those of the Fraunhofer FOKUS-Akademie [L7]. In response to high demand, the middleware is being opened up to external companies that value the independence of certain solutions.

Links:

- [L1] <https://kwz.me/hKr>
- [L2] <https://kwz.me/hKY>
- [L3] <https://www.imsglobal.org/cc/>
- [L4] <https://www.imsglobal.org/metadata/>
- [L5] <https://www.imsglobal.org/question/>
- [L6] <https://www.adlnet.gov/projects/xapi/>
- [L7] <https://akademie.fokus.fraunhofer.de/>

References:

- [1] A. Streicher, J. D. Smeddinck: “Personalized and adaptive serious games”, *Entertainment Computing and Serious Games*. Springer, 2016. 332-377.
- [2] C. Krauss, et al.: “Teaching Advanced Web Technologies with a Mobile Learning Companion Application”, in: *Proc. of mLearn 2017, ACM, , Larnaca, Cyprus*.
- [3] C. Krauss, A. Merceron, S. Arbanowski: “Smart Learning Object Recommendations based on Time-Dependent Learning Need Models”, in *Proc. of EDM 2019, M. Desmarais, et al. (eds.), pp. 599 - 602, July 2-5, 2019, Montréal, Canada*.

Please contact:

Christopher Krauss
Fraunhofer FOKUS, Germany
christopher.krauss@fokus.fraunhofer.de

Manfred Hauswirth
Fraunhofer FOKUS, Germany
manfred.hauswirth@fokus.fraunhofer.de

Fraunhofer IAIS IoT Programming Language NEPO® in the Open Roberta® Lab

by Thorsten Leimbach (Fraunhofer IAIS), Daria Tomala (Fraunhofer IAIS)

Technology now pervades all areas of our lives, including our home life, education and work. As society becomes increasingly digitalised, digital skills such as “computational thinking” are becoming more important – this applies to children in school, adults in the workforce and senior citizens alike.

At Fraunhofer Institute for Intelligent Analysis and Information Systems IAIS, the business unit “Smart Coding and Learning” is dedicated to the topic of conveying digital skills, such as coding, in a sustainable way, regardless of gender, age or prior knowledge. As part of this, the educational program “Roberta® – Learning with robots” [L1] has been successfully accompanying teachers as well as inspiring students in STEM subjects since 2002. To date

“Roberta” has reached over 450,000 children in Germany. This is one of Europe’s largest STEM initiatives, its expansion being due in part to the EU project “Roberta goes EU” [L4]. In addition to the success of its hands-on didactic concept, one key component of the project is the development and implementation of new technology: the open-source programming environment “Open Roberta Lab” and the visual programming language NEPO® in partic-

ular, both initiated with the support of Google.org.

“Open Roberta Lab” is an integrated programming environment (IDE) that is available online, free of charge [L2]. As a state-of-the-art and open source cloud programming technology (CPT), it enables the web-based programming of hardware systems, such as robots and microboards, with the programming language NEPO on any computa-

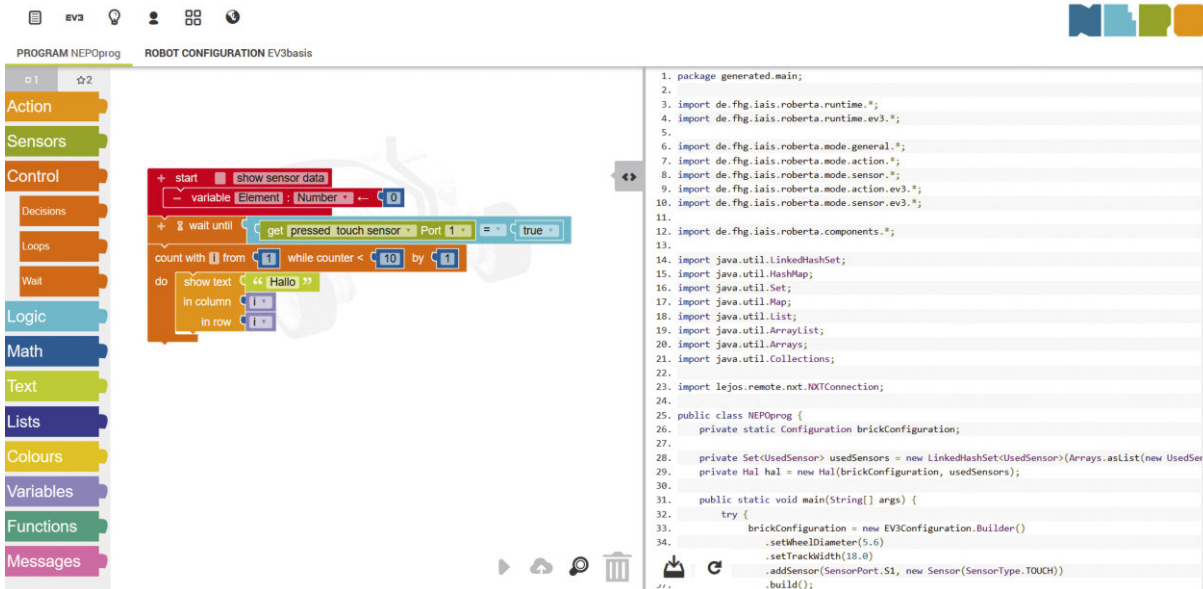

Figure 1: the Open Roberta Lab. On the left the NEPO blocks, on the right the corresponding generated source code.

tional device (e.g., smartphone, tablet, PC) and on standard operating systems (e.g., Mac OS, Linux, Windows) in which conventional browsers run. This independence of computational devices and operating systems as well as the web-based approach itself (i.e., no installation is needed), minimises the technical obstacles faced by many users, especially in educational and workplace environments, and supports the adoption and potential purview of the technology.

The enthusiastic reception to Open Roberta is reflected in the continuously growing number of users worldwide since its launch in 2014. In 2015 the Open Roberta Lab recorded 11,000 visitors, while in 2017 the website was visited more than 107,000 times. By October 2019 this number more than tripled to a total of 336,270 users from + 100 countries.

One key to the success of the platform is NEPO, the intuitive graphical program-

ming language made by Fraunhofer IAIS. NEPO (New Easy Programming Online) reduces the complexity of text-based programming languages, without being inferior in scope and performance. Despite its block-based approach, NEPO is a full programming language that allows the creation of programs containing any regular coding components, such as commands, control structures, lists, variables and functions.

The programming principle is easily understood: The coding components in the form of NEPO blocks are adjusted via “drag and drop” to a pre-defined starting point of the program and are themselves colour-coded to allow the recognition of semantics beforehand and therefore to minimise errors. The block-based structure enables syntactic errors to be avoided altogether. Furthermore, the textual designation of the respective blocks makes it possible to quickly understand the functionality of the program created. The CPT framework also provides online help to indi-

vidual NEPO coding blocks as well as the ability to integrate short tutorials.

NEPO allows anyone without previous knowledge to code even sophisticated robotic systems with various sensors and actuators in less than five minutes. So far, it has been successfully used by a wide audience: from primary schools, high-schools and universities, to coding hubs and computer clubs for the elderly and even in industrial and workplace training.

As mentioned above, an increasing variety of robotic systems is programmable with Open Roberta. What started as a platform to let users code one robot alone, has now advanced into a multi-system programming solution that lets users code a wide range of robotic systems intuitively. Starting with educational robots and microcontrollers for children aged 7+, humanoid robots, physical computing platforms, smart home devices or other Internet of Things (IoT) applications for the personal use, through to potential applications in the industrial sector.

Since NEPO blocks are specially designed by Fraunhofer IAIS to fit any chosen target system and can therefore be adapted into a customised solution, the areas of application are almost endless. On the website, the code generation – from NEPO Blocks to textual programming languages, such as Python and Java, C – runs completely on Fraunhofer servers in Germany. However, a copy of the open source server itself can be ported to other systems, e.g., Raspberry Pi [L3].

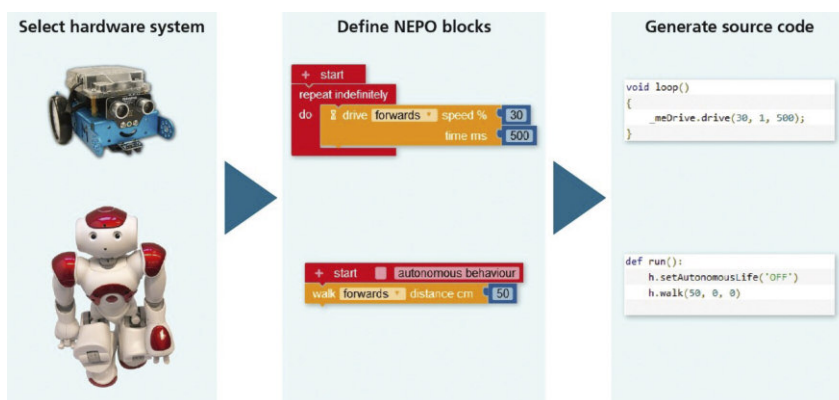

Figure 2: NEPO blocks can be individually adapted to the respective hardware system.

The functionalities of the Open Roberta Lab also include: availability in 17 languages, a gallery to share programs online, a virtual simulation and the ability to describe the programs as well as to look into the textual source code behind the NEPO blocks. This combination of features results in a low-threshold and sustainable introduction to coding.

Open Roberta follows the well-proven concept of “Roberta”, to make abstract constructs in coding tangible and easily understood by a wide audience. In combination with teacher trainings, teaching materials and a nationwide network, Open Roberta is becoming increasingly

integrated into classrooms – in the full spectrum from primary schools to universities. The project, based at Fraunhofer IAIS, is now aiming to extend its approach to one of the major research and impact fields of Fraunhofer IAIS, artificial intelligence (AI).

Links:

- [L1] <https://www.roberta-home.de/>
- [L2] <https://lab.open-roberta.org/>
- [L3] <https://kwz.me/hKB>
- [L4] <https://kwz.me/hKb>

References:

- [1] B. Jost, et al.: “Graphical Programming Environments for Educational Robots: Open Roberta -

Yet another One?”, IEEE MTEL workshop in conjunction with ISM 2014.

- [2] M. Ketterl, et al: “Open Roberta - a Web Based Approach Visually Program Real Educational Robots”, LOM, ISSN: 1903-248X.
- [3] A. Bredendfeld, T. Leimbach, “The Roberta® Initiative”, in: Proc. of SIMPAR 2010, Darmstadt (Workshop Teaching robotics, teaching with robotics), 2010, S. 1-2.

Please contact:

Daria Tomala
Fraunhofer IAIS, Germany
annette.daria.tomala@iais.fraunhofer.de

Modelling Student Learning and Forgetting for Optimally Scheduling Skill Review

by Benoît Choffin (LRI), Fabrice Popineau (LRI) and Yolaine Bourda (LRI)

Current adaptive and personalised spacing algorithms can help improve students' long-term memory retention for simple pieces of knowledge, such as vocabulary in a foreign language. In real-world educational settings, however, students often need to apply a set of underlying and abstract skills for a long period. At the French Laboratoire de Recherche en Informatique (LRI), we developed a new student learning and forgetting statistical model to build an adaptive and personalised skill practice scheduler for human learners.

Forgetting is a ubiquitous phenomenon of human cognition that not only prevents students from remembering what they have learnt before but also hinders future learning, as the latter often builds on prior knowledge. Fortunately, cognitive scientists have uncovered simple yet robust learning strategies that help improve long-term memory retention: for instance, spaced repetition. Spacing one's learning means to temporally distribute learning episodes instead of learning in a single “massed” session, i.e., cramming. Furthermore, carefully selecting when to schedule the subsequent reviews of a given piece of knowledge has a significant impact on its future recall probability [1].

On the other hand, concerns about the “one-size-fits-all” human learning paradigm have given rise to the development of adaptive learning technologies that tailor instruction to suit the learner's needs. In particular, recent research effort has been put into developing adaptive and personalised spacing schedulers for improving long-term memory retention of simple pieces of knowledge.

These tools sequentially decide which item (or question, exercise) to ask the student at any time based on her past study and performance history. By focusing on weaker items, they show substantial improvement of the learners' retention at immediate and delayed tests compared to fixed review schedules. Some popular flashcard learning tools, such as Anki and Mnemosyne, use this type of algorithm.

However, adaptive spacing schedulers have historically focused on pure memorisation of single items, such as foreign language words or historical facts. Yet, in real-world educational settings, students also need to acquire and apply a set of skills for a long period (e.g., in mathematics). In this case, single items potentially involve several skills at the same time and are practiced by the students to master these underlying skills. With this ongoing research project, we aim at developing skill review schedulers that will recommend the right item at the right time to maximise the probability that the student will correctly apply these skills in future items. An

example skill reviewing policy from an adaptive spacing algorithm is given in Figure 1.

To address this issue, we chose to follow a model-based approach: a student learning and forgetting model should help us to accurately infer the impact on memory decay of selecting any skill or combination of skills at a given timestamp. Previous work from Lindsey et al. [2] had similarly chosen to select the item whose recall probability was closest to a given threshold: in other words, recommending the item that is on the verge of being forgotten. Unfortunately, no student model from the scientific literature was able to infer skill mastery state and dynamics when items involve multiple skills.

To bridge this gap, we developed a new student learning and forgetting statistical model called DAS3H [3]. DAS3H builds on the DASH model from Lindsey et al. [2]. DASH represents past student practice history (item attempts and binary correctness outcomes) within a set of time windows to

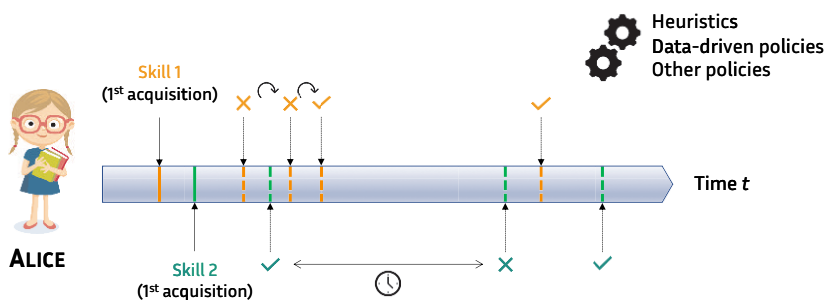

Figure 1: Example skill reviewing schedule from an adaptive spacing algorithm. Solid line indicates the first acquisition of a skill and the dashed line, the subsequent reviews of that skill. Alice is trying to master two skills (resp. in orange and green) with an adaptive spacing tool. She first reviews skill 1 but either because she already forgot it or because she did not master it in the first place, she fails to recall it and is rapidly recommended to review it again. The situation is different for skill 2: her first attempt is a win and the algorithm makes her wait longer before reviewing it again. Diverse methods can be used to personalize spacing: heuristics, data-driven reviewing policies, etc.

predict future student performance and is inspired by two major cognitive models of human memory, ACT-R and MCM. Most importantly, DASH has been used in a real-world experiment [2] to optimise reviewing schedules for Spanish vocabulary learning in an American middle school. Compared to a fixed review scheduler, the personalised DASH-based algorithm achieved a 10% improvement at a cumulative exam at the end of semester. Our model DAS3H extends DASH by incorporating item-skills relationships information inside the model structure. The goal was both to improve model performance when prior information is at hand and to use the model estimates of skill mastery state and memory dynamics it encapsulates to prioritise item recommendation.

To evaluate our model’s potential use in an adaptive and personalised spacing algorithm for reviewing skills, it was necessary to first compare its predictive power to that of other student models on real-world data. Thus, we tested DAS3H on three large educational datasets against four state-of-the-art student models from the educational data mining literature. We split the student population into five disjoint groups, trained all models each time on four groups and predicted unknown student binary outcomes on the fifth group. On every dataset, DAS3H showed substantially higher predictive performance than its counterparts, suggesting that incorporating prior information about item-skills relationships and the forgetting effect improves over models that consider one or the other. Our Python

code has been made public on GitHub: see [L1].

Besides its performance, our model DAS3H has the advantage of being suited to the adaptive skill practice and review scheduling problem that we are trying to address. For instance, it could be used at any timestamp to predict the impact of making the student review each skill and then to select the most promising skill or combination of skills. In future research, we intend to investigate heuristics and data-driven policies for selecting items to maximise long-term memory retention on a set of underlying skills.

Link:

[L1] <https://kwz.me/hKt>

References:

- [1] N. J. Cepeda et al.: “Spacing effects in learning: A temporal ridge of optimal retention”, *Psychological science*, 19(11), 2008
- [2] R. V. Lindsey et al.: “Improving students’ long-term knowledge retention through personalized review”, *Psychological science*, 25(3), 2014
- [3] B. Choffin et al.: “DAS3H: Modeling Student Learning and Forgetting for Optimally Scheduling Distributed Practice of Skills”, *Educational Data Mining*, 2019

Please contact:

Benoît Choffin
 Laboratoire de Recherche en Informatique (LRI), France
benoit.choffin@lri.fr

Ontology-based Learning Analytics in Medicine

by Fabrice Jouanot (Univ. Grenoble Alpes), Olivier Palombi (Univ. Grenoble Alpes, CHU de Grenoble) and Marie-Christine Rousset (Univ. Grenoble Alpes, IUF)

Through SIDES 3.0, we are developing an ontology-based e-learning platform in medicine to make learning analytics transparent and explainable to end-users (learners and teachers). In this project, the educational content, the traces of students’ activities and the correction of exams are linked and related to items of an official reference program in a unified data model. As a result, an integrated access to useful information is provided for student progress monitoring and equipped with a powerful query language allowing users to express their specific needs relating to data exploration and analysis.

The goal of SIDES 3.0 is to empower medical students and teachers in data analytics to enable them to take charge of their own progress monitoring and training.

We have followed the Semantic Web [1] and Linked Data [2] standards for the semi-automatic and modular construction of OntoSIDES [3], a knowledge graph comprising a lightweight domain

ontology serving as a pivot high-level vocabulary of the query interface with users, and of a huge dataset that is automatically extracted from SIDES dumps using mappings. Both the ontological

Information about student `sides:etu12402`

Figure 1: Parametrized queries for students.

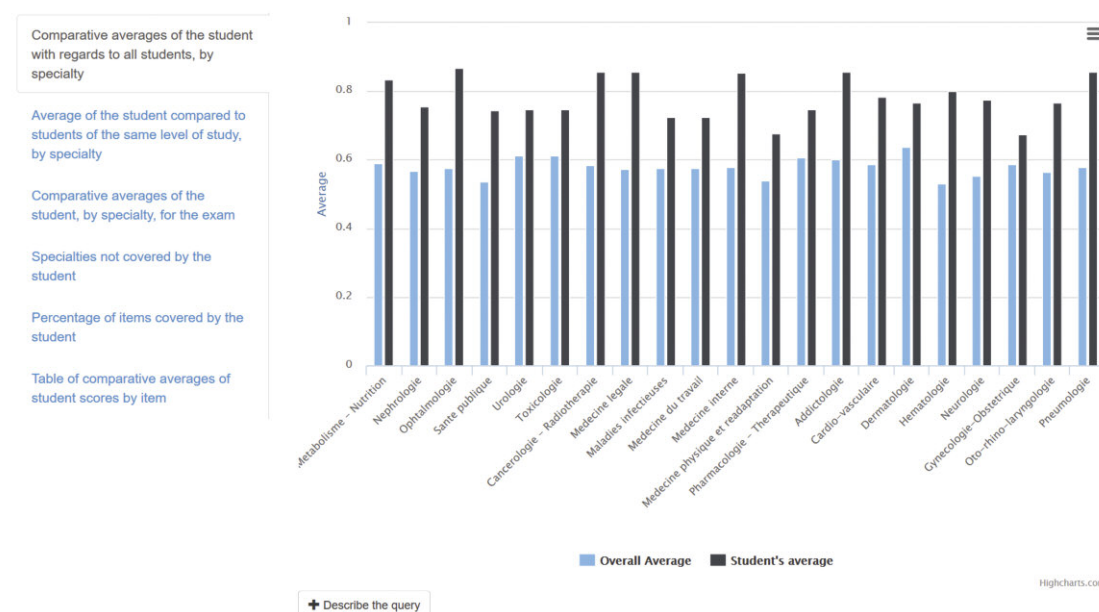

statements and the factual statements are uniformly described in RDF format [L1], which makes it possible to query OntoSIDES using the SPARQL query language [L2].

It is important to note that no personal data concerning students are extracted from SIDES. Instances of students in OntoSIDES are just represented by identifiers of the form `sides:etu12402` (as shown in Figure 1).

The current version of the OntoSIDES knowledge graph has scaled up to 6,5 billion RDF triples describing training and assessment activities performed by more than 145,000 students over almost six years on the SIDES French national e-learning platform. In OntoSIDES, exams and training tests are made up of multiple choice questions and student activities are described at the granularity of time-stamped clicks of students' selected answers to each question.

Through SPARQL queries, students can explore parts of the program that they haven't yet studied, or launch a comparative analysis of their own progress in a specific part of the program. The same mechanisms let teachers analyse the strengths and weaknesses of their class compared to other groups at the same study level in other universities.

Since we do not expect end-users to master the raw syntax of SPARQL and

to express directly complex queries in SPARQL, we have designed a set of parametrised queries that users can customise through a user-friendly interface. Figure 1 shows the interface for students who can choose to launch one of the queries in the left column that will be parametrised by the student's identifier (`sides:etu12402` in the example). The chart in the right side of the figure shows the result returned to the first query for that student, i.e., the average results obtained per specialty by the student (to all the questions he/she answered related to this specialty), compared to the overall average obtained per specialty by the whole group of active students.

This methodology is not specific to medicine; it can be applied to other disciplines for enriching or building learning management systems. The effort required depends mainly on the existence of a reference standard for the educational program in the target discipline.

SIDES 3.0 is an ongoing project funded by the French Programme Investissement d'Avenir (PIA) through the ANR call DUNE (Développement d'Universités Numériques Expérimentales). It is conducted under the authority of UNES (Université Numérique en Santé et en Sport) and involves Université Grenoble Alpes, Inria, and Ecole Normale Supérieure as partners. It is

built upon the SIDES e-learning platform, which has been used since 2013 by all medical schools in France for online graduation and assessment.

Links:

- [L1] <http://www.w3.org/TR/rdf-concepts/>
[L2] <https://www.w3.org/TR/>

References:

- [1] D. Allemang, J. Hendler: "Semantic Web for the Working Ontologist: Modeling in RDF, RDFS and OWL", Morgan Kaufmann, 2011.
[2] T. Heath, C. Bizer: "Linked Data : Evolving the Web into a Global DataSpace", Morgan and Claypool, 2011.
[3] O. Palombi, et al.: "OntoSIDES: Ontology-based student progress monitoring on the national evaluation system of French Medical Schools", Artificial Intelligence in Medicine, vol 96, 2019.

Please contact:

Marie-Christine Rousset
Univ. Grenoble Alpes, France
Marie-Christine.Rousset@univ-grenoble-alpes.fr

Blockchain for Education: Lifelong Learning Passport

by Wolfgang Prinz, Sabine Kolvenbach and Rudolf Ruland (Fraunhofer FIT)

Certificates are important to document educational attainments, and educational documentation is required when it comes to job-seeking and career advancement. It is therefore vital that these records are stored in long-term available and tamper-proof ledgers. The Blockchain for Education platform is a secure and intuitive solution for issuing, sharing, and validating of certificates.

Universities and other educational institutions confirm degrees and achievements of certain learning outcomes by issuing certificates, which, to date, have largely been issued on paper or other physical formats. Certificates include several statements, the most important being: the qualification or academic title attained, the name and address of the issuer organisation, the name and signature of the certifier who has validated the facts and is certifying that the qualification is true, the name of the learner and the date of the examination. Some certificates include additional statements, such as the period of validity.

Students usually receive the certificate as a paper document or PDF. This kind of document has the disadvantage of being difficult to verify, and issuing institutions need to maintain a registry or database for certificates for a long period of time [1]. Employers can only check a certificate's authenticity by requesting confirmation from the issuing organisation, which is time-consuming and expensive, and thus often avoided. Consequently, a billion-dollar industry in fraudulent degrees has developed [2], with fake educational certificates being available for purchase online. Certification authorities, universities, and educational institutions have expressed a need for a secure and intuitive solution. Digital standardised documents and blockchain technology

seem ideal to solve many of the above-mentioned problems.

Solution

Blockchain for Education is a web-based platform that supports counterfeit protection as well as secure management and easy verification of certificates according to the needs of educational institutions, learners, and employers. It ensures greater efficiency and improved security for certification authorities through digitisation of current processes, issuing and registering of certificates in a blockchain as well as automatic monitoring of certificates. To follow the Industrie 4.0 approach [L1] the platform supports machine-readable certificates using an extension of Open Badges [L2].

Our solution supports the whole process from the administration of certificate templates and examination data to the registration of signed certificates in the blockchain to the final check of the validity of the certificate by an HR department, as illustrated in Figure 1. It should be noted that the information registered in the blockchain does not include the learner's personal data, i.e. the protection of privacy for learners is ensured. Furthermore, the platform enables certification authorities to revoke certificates. This could be necessary when plagiarism has been detected, misconduct of the certified learner was proven, or learners have

not provided evidence of required refreshment trainings.

Learners can securely manage their certificates and degrees in their wallet via an intuitive App running on smartphones, tablets, and PCs. The wallet visualises the imported certificates, monitors certificates with a time-limited validity and indicates expirations, and provides an easy means to share certificates with potential employers. Learners can also print the certificate. The QR-code on the document contains the verification URL.

Trustworthy verification of certificates is guaranteed for employers by an easy to use web-based proof service. When employers receive the certificate, they can upload it by drag and drop on the proof service or scan the QR-code with a smartphone. The verification service verifies the given data in the blockchain, performs the proof of origin, and presents the check result. In addition to verifying individual certificates, human resources departments can gain verification overviews of employees' certificates. For example in the financial sector this simplifies and accelerates proceedings towards the regulatory authority.

The Blockchain for Education platform is based on the Quorum Blockchain with consensus algorithm Istanbul BFT, including two smart contracts, the

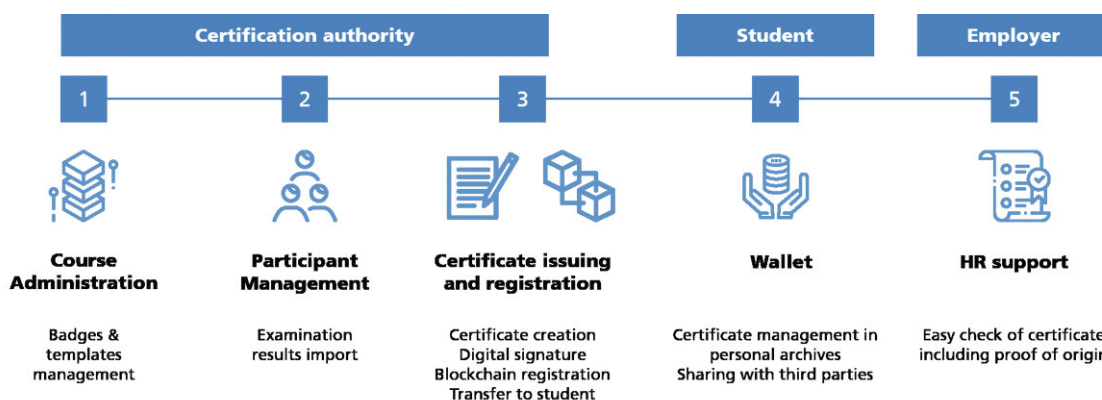

Figure 1: Certification process supported by Blockchain for Education.

InterPlanetary File System (IPFS), a document management system, and the wallet. The first smart contract registers the identities of certification authorities and certifiers, the second smart contract registers the fingerprints of the certificates. The IPFS holds profile information of certification authorities. The document management system for issuing institutions manages the actual payload of certificates and the parties involved in the process, namely accreditation and certification authorities, certifiers, learners, and human resources departments. The API enables the integration with existing infrastructures such as the learning management system Moodle.

Product launch

The Blockchain for Education platform was developed in an iterative and incremental process in strong collaboration

with certification authorities and universities [3]. A first platform prototype was successfully demonstrated on CEBIT 2018. We are continuously extending and enhancing the system. In December 2019 we will launch the product; our first customer is the Fraunhofer Personnel Certification Authority [L3]. In parallel we initiated DigiCerts [L4], a network of universities and educational institutions that aims to collaboratively develop standards and solutions in certification processes. The network is an open network and we invite other members from the ERCIM community to join it.

Links:

- [L1] <https://kwz.me/hKd>
- [L2] <https://openbadges.org/>
- [L3] <https://kwz.me/hKc>
- [L4] <https://www.digicerts.eu/>

References:

- [1] A. Grech, A. F. Camilleri: “Blockchain in Education”, No. JRC108255, Joint Research Centre (Seville site), 2017.
- [2] A. Ezell, J. Bear: “Degree mills: The billion-dollar industry that has sold over a million fake diplomas”, Pyr Books, 2005.
- [3] W. Gräther, et al.: “Blockchain for Education: Lifelong Learning Passport”, ERCIM Blockchain Workshop 2018: Blockchain Engineering: Challenges and Opportunities for Computer Science Research, Amsterdam 2018. doi:10.18420/blockchain2018_07.

Please contact:

Sabine Kolvenbach,
Fraunhofer FIT, Germany
sabine.kolvenbach@fit.fraunhofer.de

An Educational Platform for Logic-based Reasoning

by Dimitrios Arampatzis (FORTH-ICS), Maria Doulgeraki (FORTH-ICS), Michail Giannoulis (Univ. of Crete), Evropi Stefanidi (FORTH-ICS), and Theodore Patkos (FORTH-ICS)

EduBAI (Educational Basketball playing using Artificial Intelligence) is an educational platform that helps users familiarise themselves with the main tenets of common-sense reasoning in dynamic, causal domains, by means of an interactive entertaining environment. This article discusses the design and features of the platform, along with the rationale of sample game tactics of diverse modelling complexity.

Formal action languages are well-established logical theories for reasoning about the dynamics of changing worlds, contributing solutions to domains as diverse as high-level robot cognition, ambient intelligence and complex event detection. The heterogeneous application areas of these formalisms attract the interest of researchers from a variety of disciplines and with diverse backgrounds. Given the quite advanced technical training needed to master logic-based reasoning, the educational process of understanding both the theoretical and practical aspects of common-sense reasoning is a challenging task.

EduBAI [1] (Educational Basketball playing using Artificial Intelligence) aims to facilitate the learning process of logic-based reasoning. EduBAI is a game platform that assists students and researchers having basic knowledge of the underlying formalisms in writing, executing and evaluating logic-based axiomatizations. It offers a testbed for experimenting with a rich range of rea-

soning features, structured around a game scenario involving three-player teams competing against each other in a basketball match. The gameplay gives the ability to explore aspects related to causality-based reasoning, geospatial reasoning, multi-player coordination, temporal reasoning, probabilistic reasoning, function optimisation and others.

The platform was developed in the context of a post-graduate knowledge representation and reasoning course at the Computer Science Department of the University of Crete and has been co-developed by students. The gamification nature of the approach aims to offer a more entertaining way of introducing logic-based programming, motivated by the observation that toy problems in the form of grid settings and logic puzzles have proven to be an effective way of understanding insights of AI programming. The platform is free-to-use and available online for testing and play [L1].

Users of the platform model the intelligence of their team using formal languages, such as the Event Calculus and Answer Set Programming (ASP), in the context of a dynamic, non-deterministic domain. The Event Calculus is a narrative-based many-sorted first-order language for reasoning about action and change, while ASP is a declarative problem-solving paradigm oriented towards complex combinatorial search problems.

Each of the six players can move within the premises of the EduBAI basketball court, represented as a 5×7 grid (Figure 1). The players can perform only a limited set of actions, namely shoot, move (up, down, right, left) and pass. Player actions are contingent on appropriate preconditions; for instance, a player can perform a pass only if she is in possession of the ball. Moreover, the outcome of each action is decided probabilistically, e.g., a shoot action has 95% probability of being successful if it occurs in the same cell as the basket;

distance from the basket reduces the prior probability by 17% per cell, whereas each opponent in the same cell reduces the probability by 25%. The game proceeds in rounds. At the beginning of each round, the human users decide the starting position of their players, as well as the defending and attacking tactic that their team will follow during the round; these tactics cannot change in the course of the given round, therefore once this initialisation step is completed, the game proceeds without any human user intervention.

One of the objectives of the EduBAI platform is to help users understand the main principles of causality-based reasoning, through the axiomatization of their own attacking and defending team tactic intelligence. EduBAI enables the user to experiment with features of increasing complexity, still presenting an operational team every time, permitting a gentle introduction to the modelling concepts. Tactic encodings can start by ignoring the opponent positions, for instance, and only follow specific, pre-defined patterns; or they may consider spatial and topological relations among players, probabilistic reasoning on the effects of actions, cost function optimisations etc.; they may even take into account past actions, in order to learn patterns and predict future moves.

EduBAI consists of multiple web services that expose their functionality either via a Rest API or a web-socket connection. The core components of the platform involve: the User and User Status Services, nodeJS services that

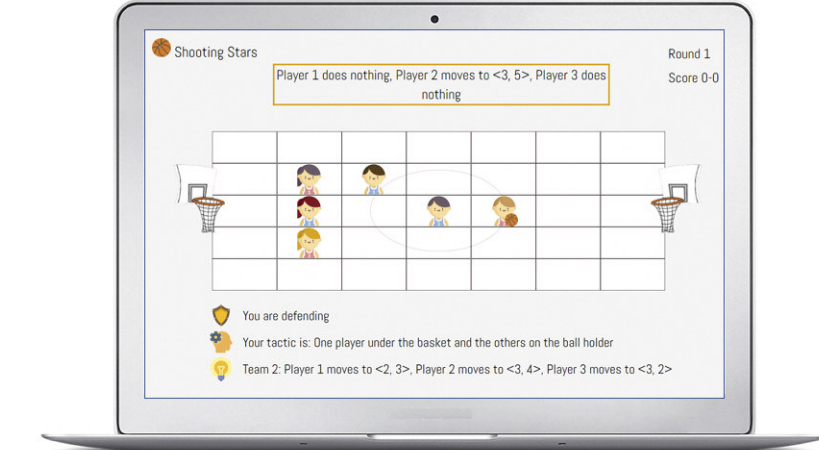

Figure 1: Snapshot of the EduBAI UI.

store, manage, and serve data about users and their game sessions; the Tactics Service, that manages custom tactics and provides a Restful API developed using nodeJS that allows the uploading of ASP code; the Players Positioning Service for real time connection between users, using nodeJS and webSockets; the Game System, a Java web service responsible for running a game session and for calling the Clingo ASP solver to execute reasoning tasks; and, the Graphical User Interface, which is Web-based and implemented using HTML, CSS and JavaScript, designed with respect to human-computer interaction (HCI) principles.

Future plans involve extending the platform with friendly interactive features that will further enhance the educational experience - for example, an embedded editor to enable users to encode their tactics or a tutorial-style assistant to

walk a new user through the main functionalities. In addition, we plan to offer a more advanced competition environment, where the users can schedule matches or upload their own AI-enabled bots and keep track of online statistics.

Link:
[L1] <http://139.91.183.97:8181/edubai/>

Reference:
[1] D. Arampatzis, et al.: “EduBAI: An Educational Platform for Logic-Based Reasoning”, in: *Artificial Intelligence Applications and Innovations, AIAI 2019, IFIP Advances in Information and Communication Technology*, pp. 464-472 vol 559, 2019.

Please contact:
Theodore Patkos, Dimitrios Arampatzis, FORTH-ICS, Greece
patkos@ics.forth.gr, rabatzi@ics.forth.gr

Authoring Game-Based Learning Activities that are Manageable by Teachers

by Pedro Cardoso (FEUP/ FBAUP and INESC TEC), Leonel Morgado (Universidade Aberta and INESC TEC), and António Coelho (FEUP and INESC TEC)

The great ambition of using games as the cornerstone of education is hindered by its associated teaching workload. The BEACONING project developed a framework based on an authoring tool for gamified lesson paths, which has been rolled-out in large scale across Europe. It includes stages for planning game-based educational activities, plus their deployment, monitoring, and assessment.

Games are great tools for learning and as such many teachers wish to employ them in their teaching practices. Notwithstanding, using games in education is hard. It is hard to plan the time

and the teachers’ tasks; the students’ activities; to keep track of what each student is doing; to assess and provide feedback, and so on – and all these obstacles encumber and limit educa-

tional adoption of games [1]. The BEACONING project [L1] acknowledges this and created the concept of a gamified lesson path [2], by linking game plots (the narrative and level design)

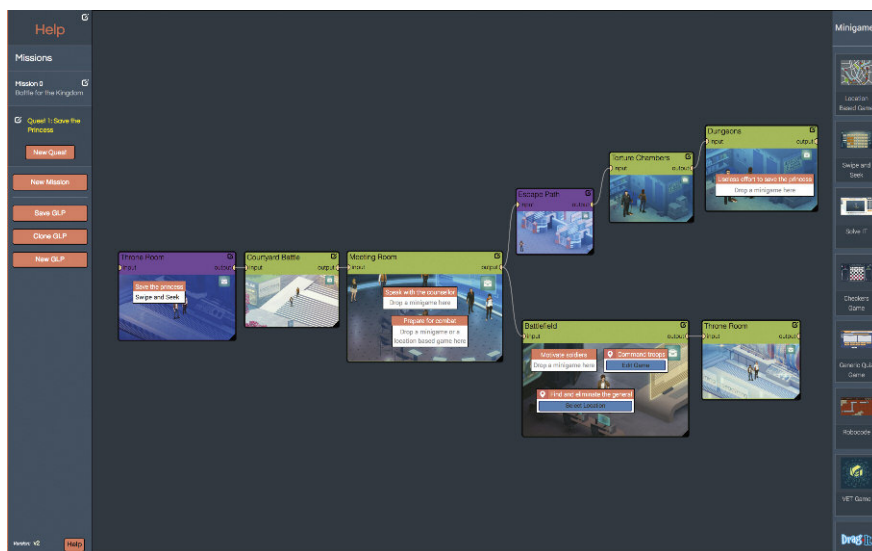

Figure 1: Gamified Lesson Plan with branching activities, viewed in the authoring tool [L2].

provided by game development companies with educational activities within a triadic assessment model [3]. Using an authoring tool developed at INESC TEC (Figure 1), a learning designer creates a gamified lesson path by selecting a game plot, linking learning activities structured as missions and quests into it, and finally by associating those activities with specific learning goals and challenges (mini-games). Learning designers are either experts at creating educational content, within companies and organisations, or teachers with training in this area. By selecting a gamified lesson path, teachers can automatically deploy games to their students, adapting them to specific individual requirements.

Not only students receive the games as part of educational activities from their teachers, but this deployment is also linked to the learning management platforms: teachers can track which students have not yet started learning within a gamified lesson plan, which ones are currently amidst it and where, and which students have finished it and how. Students can also track which teachers and courses have assigned them gamified lesson plans, and how they are progressing in each.

All of this linking is done via anonymization, using the BEACONING platform as middleware, so that gaming companies can deploy games to individual students over the Web without actually knowing who each student is: individual details are kept within the

learning management system and retrieved directly by the game on students' smartphones, without being sent to the companies or even to the middleware. BEACONING provides each student's game with information on the actual web call to retrieve information such as player names, but this transit of information occurs solely between the student's smartphone and the school's learning management system.

By using BEACONING to track students' progress, teachers can better manage their time and effort allocation when employing videogames in school, thus reducing their workload and empowering them to use these as a reliable and regular pedagogic approach "anytime and anywhere". This authoring and deployment pipeline have now been successfully rolled out in large-scale testing across Europe (Figure 2) [L2].

BEACONING's prototype and authoring pipeline approach holds the potential for application in many other non-traditional learning activities. Beyond gaming, we are exploring and expanding this approach to enable widespread deployment of active learning, location-based learning, immersive environments, outdoor activities, and more.

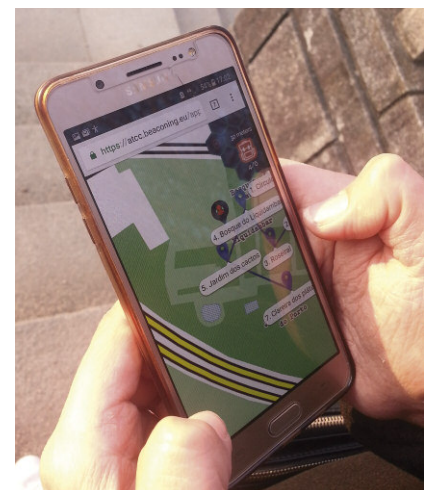

Figure 2: Interface of a location-based activity used in pilot testing of the BEACONING platform.

Links:

- [L1] <https://www.beaconing.eu/>
 [L2] <https://beaconing.eu/wp-content/uploads/deliverables/D6.3.pdf>

References:

- [1] B. B. Marklund, A. S. A. Taylor: "Educational Games in Practice: The Challenges Involved in Conducting a Game-Based Curriculum", *Electronic Journal of e-Learning*, 14(2), 122-135, 2016
 [2] A. Bourazeri, et al.: « Taxonomy of a Gamified Lesson Path for STEM Education: The Beaconing Approach », in *European Conf. on Games Based Learning* (pp. 29-37). Academic Conferences International Ltd, 2017.
 [3] R. Baptista, A. Coelho, C. V. de Carvalho: "Relation Between Game Genres and Competences for In-Game Certification", in *Int. Conf. on Serious Games, Interaction, and Simulation* (pp. 28-35). Springer, 2015.

Please contact:

António Coelho
 FEUP & INESC TEC, Portugal
acoelho@fe.up.pt

Leonel Morgado
 Universidade Aberta & INESC TEC,
 Portugal
leonel.morgado@uab.pt

LudiMoodle: Adaptive Gamification to Improve Learner Motivation

by Élise Lavoué (Université Jean Moulin Lyon 3)

The LudiMoodle project aims to adapt game elements integrated into the Moodle learning environment to help motivate learners.

The gamification field has been growing over the last decade. Most studies that have investigated the use of gamification in education have highlighted its benefits in terms of learner performance and motivation. However, these studies have generally focused on short-term effects, and do not differentiate between the impact of each game element according to the context or the learner profile. More recent studies, considering the impact of each game element separately, have shown that their impact depends on the learner profile [1] (e.g., motivation, player type, personality traits), with some game mechanisms being detrimental to specific learners [2]. For instance, in a previous study, we showed that amongst the most engaged learners (i.e., learners who use the environment the longest), those with adapted game elements spend significantly more time in the learning environment [3].

In this context, the LudiMoodle [L1] project aims to acquire new insights into the impacts of specific game elements, including: timer; leaderboard; progress; avatar; badges and scores, on learner motivation when using a digital learning environment (Figure 1). The project will provide (i) researchers with a model for

the adaptation of game elements to the learner profile; (ii) instructional designers with a generic plugin to gamify resources offered in the Moodle learning environment; and (iii) teachers with recommendations to gamify their courses in a way that motivates learners with different profiles and motivation.

The project is led by the University of Lyon [L2]. It involves the education authority (Rectorat) of Lyon [L3], researchers both in computer sciences (LIRIS lab [L4]) and educational sciences (ECP lab [L5]), instructional designers from the University Lyon 3 [L6] for the design of digital learning resources in close collaboration with teachers, as well as the Edunao [L7] company dedicated to the development of the game elements. Ground experiments are conducted in middle schools of the Lyon Educational District. Teachers are involved in the design of game elements during participatory design sessions to create meaningful and motivating game elements.

The four-year project began in January 2017. We ran a first experiment in March-April 2019 over ten course sessions that involved 258 fourth grade

pupils in four middle-schools, in a mathematics course. Learners used individual tablets that displayed exercises and they were guided in the digital environment. The six game elements were randomly assigned to learners, one game element per learner, to answer two research questions: (i) How does gamification influence learner motivation? And (ii) Which factors influence the impact of game elements on learner motivation? We used questionnaires to assess the initial level of motivation of the learners before the course and the level of motivation at the end of the course. We also asked learners to fulfill the Hexad [L8] questionnaire to identify their player type. Finally, we collected all interaction traces with the learning environment to identify their performance (correct and incorrect answers) and engaged behaviours (e.g., number of exercises, time spent on an exercise, time spent to answer a question).

The first results show that learners' intrinsic and extrinsic motivation decreased during the experiment. These results are not surprising since game elements were randomly distributed amongst learners and may not fit their motivation for the course and preferences for game mechanisms. We also observed an increase in learner motivation in the students that were least motivated initially. A deeper analysis showed that two factors influenced the impact of game elements on learner motivation and performance: (i) the initial level of motivation at the beginning of the course and (ii) the player profile, achiever and player dimensions being the most important. An analysis per game element also showed that (i) each game element influences different dimensions of motivation (either intrinsic, extrinsic or amotivation); and (ii) the impact of each game element depends on a different combination of factors including the initial motivation and certain dimensions of the player profile.

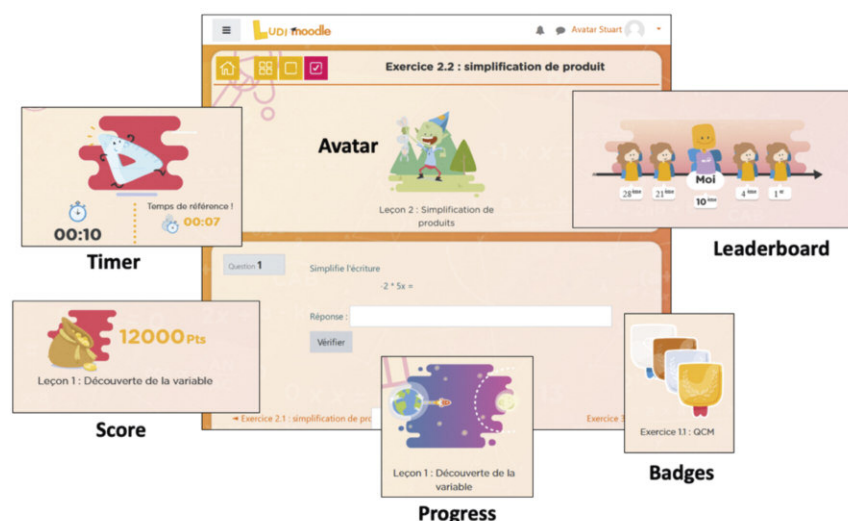

Figure 1: Game elements developed within the LudiMoodle project for the Moodle learning platform.

A second experiment is planned for March-April 2020 to identify the impact of adaptive gamification on learner motivation. An adaptation engine will be integrated into the digital learning environment. Static adaptation rules will be defined according to the factors identified in the first experiment, to propose game elements adapted to each learner's profile at the beginning of the course. We will also define a dynamic adaptation process to suggest game elements according to engaged or disengaged behaviours observed during the course via learners' interaction traces with the learning environment. At the end of the course, we will compare the impact of adapted game elements on learner motivation compared to game elements attributed randomly. We will also compare the impact of adapted game elements depending on the type of

adaptation (static vs. dynamic). We believe these studies will provide new insights into the impact of adaptive gamification on learner motivation, and recommendations for designers and teachers to adapt game elements to learners.

This work is a part of the LudiMoodle project financed by the e-FRAN Programme d'investissement d'avenir, operated by the Caisse des Dépôts.

Links:

[L1] <https://ludimoodle.universite-lyon.fr>

[L2] <https://kwz.me/hKy>

[L3] <http://www.ac-lyon.fr/>

[L4] <https://liris.cnrs.fr/en/team/sical>

[L5] <https://kwz.me/hKH>

[L6] <https://kwz.me/hKE>

[L7] <https://www.edunao.com/en/home/>

[L8] <https://www.gamified.uk/user-types/>

References:

- [1] S. Hallifax, et al.: "Factors to Consider for Tailored Gamification", CHI PLAY'19, 2019, pp. 559-572.
- [2] S. Hallifax, et al.: "Adaptive gamification in education: A literature review of current trends and developments", EC-TEL 2019, Springer, pp. 294-307.
- [3] E. Lavoué, et al.: "Adaptive Gamification for Learning Environments", IEEE TLT, 12, 1, pp. 16-28, 2018.

Please contact:

Élise Lavoué

Université Jean Moulin Lyon 3, France
elise.lavoue@univ-lyon3.fr

Can Tangible Robots Support Children in Learning Handwriting?

by Arzu Guneyusu Ozgur, Barbara Bruno, Thibault Asselborn and Pierre Dillenbourg, (EPFL)

A large body of research suggests that robots could indeed be useful for supporting children in learning handwriting. However, few studies have investigated the role and use of tangible robots in teaching handwriting to children with attention and/or visuo-motor coordination difficulties. Over the course of multiple iterations, globally involving 17 typically developed children and 12 children with attention and visuo-motor coordination issues within one school and two different therapy centres, we have designed a robotic activity to teach the grapheme (shape) and the ductus (the way to draw) of cursive letters.

Research shows that having richer sensory information enhances visual perception and visual-motor coordination [1]. To let children experience a range of sensory information during letter learning, teachers use techniques such as drawing letters in sand-filled boxes or touching the letters carved in a piece of wood. The same principle is adopted by therapy centres for the development of language skills, such as the "draw on your back" game. During the game, a child and a therapist take turns in drawing a letter on the other's back with their finger and guessing what is drawn.

Similarly, robots can be used as tangible tools enhancing sensory information, as we demonstrated in a previous study that used the Cellulo robots to help pre-schoolers learn the grapheme and the ductus of letters [1]. Cellulo is a palm-sized, haptic-enabled robot developed at EPFL [L1] [2] that can move and be

moved on "maps", i.e., printed sheets of paper covered with a dotted-pattern that enables accurate localisation (Figure 1 shows children interacting with their robots on letter maps). Cellulo robots are versatile, easy to set up and well-suited for classroom activities. They are controlled by an application running on a computer or a tablet and feature various interaction modalities; many such robots can also be simultaneously used as a "swarm" in an activity [3].

Our goal, inspired by interactions with teachers and therapists, was to design a modular, highly engaging, highly adaptable robot-assisted activity to help children with attention and/or visuo-motor coordination issues in learning the grapheme and ductus of cursive letters.

Through several iterations within a school and a number of therapy centres, we designed an activity composed of

three sub-activities targeting different aspects of letter handwriting learning. The setup envisions multiple kids sitting at a table, each with a Cellulo and a map displaying the grapheme of the letter, as shown in Figure 1. The sub-activities are:

1. "Watch the Robot": Cellulo autonomously moves along the letter's grapheme on the map, following the ductus. The child only watches the robot and the letter's phoneme is played at the beginning and end of the robot's writing, to strengthen the link with the corresponding grapheme and ductus.
2. "Feel the Robot": We ask the child to put their hand on Cellulo while it moves along the letter's grapheme to passively feel the motion of the robot. Experiments with children with visuo-motor coordination difficulties highlighted the importance of this activity: the child has to adjust the

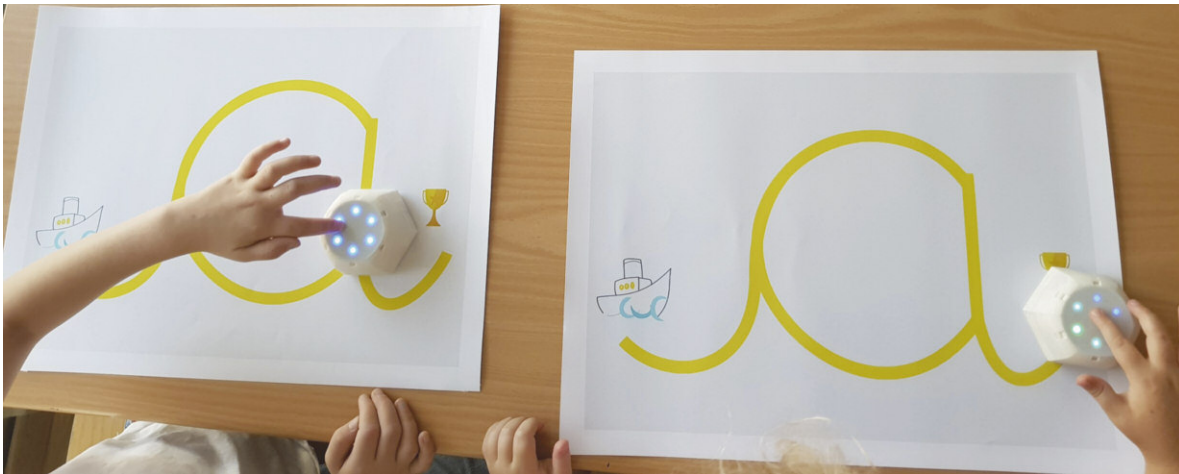

Figure 1: Robot-assisted writing activity with Cellulo: Children interact with the haptic-enabled Cellulo robots on maps displaying the grapheme of a cursive letter, where the start and end of the letter are indicated with a starting cue and a trophy respectively. After three different sub-activities where the robots provide a range of sensory information, a final team activity in the form of a guessing game is played.

force applied on top of the robot, since applying excessive force prevents the robot from moving.

3. “Drive the Robot”: The child actively drives Cellulo along the letter’s grapheme, trying to repeat the ductus seen previously. Although the child has full control over the robot’s movements, Cellulo provides haptic feedback, trying to lead the child to the right path if it is moved away from it. Additionally, Cellulo’s LEDs are blue when the correct path is followed, and red otherwise. This visual + haptic feedback helps the child recognise and avoid errors.

The design includes a final team activity in which three to four children, alternatively playing as one “writer” and many “guessers”, sit side-by-side at the table, with a barrier in between preventing the guessers from seeing the writer. Using the map as a reference, the “writer” is asked to write a letter using Cellulo as done in “Drive the Robot”. The movements of the “writer” robot are replicated in real-time by the “guesser” robots, autonomously moving on a blank map placed in front of each “guesser”. The goal of the game is for the “guessers” to successfully guess the letter drawn by the “writer”. During one iteration, therapists suggested to adapt this game to be more challenging for the “writer”: to this end, we tested the case in which the “writer” is also given a blank map and has to remember both the proper grapheme and ductus for the letter that they are instructed to write. The game thus becomes a team effort in which wrong

guesses from the “guessers” are fed back to the “writer” and the goal is for the team to make the “guessers” correctly guess the letter with the least number of attempts. This adaptation also allows us to track the progress of the child in handwriting, by analysing the “writer” robot’s trajectory.

The map also proved to be a crucial adaptation element: different institutions use slightly different graphemes for the same letter, as well as different cues for the initial strokes. For this reason, we designed multiple variants of the maps (e.g., featuring car-racing elements to introduce a gaming dimension or skate ramps and sea waves to relate to one way in which specific strokes are taught).

Finally, therapists highlighted the importance of knowledge transfer, i.e., ensuring that children who learn the appropriate ductus and grapheme with the robot are capable of writing equally well with pen and paper. Thus, in one iteration we interspersed pen-and-paper writing tasks between the sub-activities.

Encouraged by the positive results of the iterations, we are working to test the activity with more children and institutions. In sharing the lessons we learned during the design iterations we hope to inspire and support colleagues working in the field... and get useful feedback!

Link:

[L1]

<https://www.epfl.ch/labs/chili/index.html/research/cellulo/>

References:

- [1] T. Asselborn, A. Guneyesu, et al. “Bringing letters to life: handwriting with haptic-enabled tangible robots”, in Proc. of the 17th ACM Conference on Interaction Design and Children (IDC '18). ACM, New York, NY, USA, 219-230, 2018.
- [2] Ö.Özgür et al.: “Cellulo: Versatile handheld robots for education”, in 12th ACM/IEEE International Conference on Human-Robot Interaction, pp. 119-127. IEEE, 2017.
- [3] A. Özgür et al.: “Declarative Physicomimetics for Tangible Swarm Application Development”, Proc. of the 11th International Conference on Swarm Intelligence, ANTS 2018. Vol. 11172. No. CONF. 2018.

Please contact:

Arzu Guneyesu Ozgur
EPFL, CHILI (Computer-Human Interaction in Learning and Instruction Laboratory), Switzerland.
arzu.guneyesu@epfl.ch

“You Tell, I Do, and We Swap until we Connect All the Gold Mines!”

by Jauwairia Nasir, Utku Norman, Barbara Bruno and Pierre Dillenbourg (EPFL)

The Project JUSThink has a double goal: (i), to help train the Computational Thinking skills of children with a collaborative, robot-mediated activity, (ii), to acquire insights about how children detect and solve misunderstandings, and what keeps them engaged with a task, the partner or a robot. The result? An abstract reasoning task with a few pedagogical tricks and a basic “robot CEO” that can keep 100 ten-year-olds engaged, and, in turns, frustrated and jubilant!

“Computational thinking (CT) is going to be needed everywhere. And doing it well is going to be a key to success in almost all future careers.” The words of Stephen Wolfram [L1] capture the urgency of the efforts to introduce CT into educational curricula before high school. In a parallel effort, robots are being increasingly used in educational settings around the globe, with some attempts to use robots to help students advance CT skills. However, finding pedagogical designs that can help develop such skills is quite challenging.

To address the current need, the “JUSThink” project [L2], started in September 2018 at the Computer-Human Interaction in Learning and Instruction (CHILI) Laboratory at École Polytechnique Fédérale de Lausanne (EPFL), aims to improve the computational thinking skills of children by exercising abstract reasoning with and through graphs, where graphs are posed as a way to represent, reason about and solve a problem. JUSThink builds on experience from earlier work [1] and aims to foster children’s understanding of abstract graphs through a collaborative problem-solving task, in a setup consisting of a QTrobot and touch screens as input devices (shown in Figure 1). JUSThink is being developed as part of EU’s Horizon 2020 ANI-MATAS Innovative Training Network that aims to improve the social interaction capabilities of robots for learning and education [L3].

In this activity, the design is scaffolded towards and inspired by pedagogical and learning theories of collaboration and constructivism whereas the role of the robot (an informed CEO, who still needs help) is partially inspired by the protégé effect. Furthermore, the design of the activity is motivated to surface cues relevant to (i) learners’ engagement with the task at hand, their partner and the

robot, and (ii) mutual understanding and misunderstandings between the learners. Given the importance of the aforementioned cues towards the pedagogical goal of the activity, the ultimate goal of JUSThink is to enable the design of a robot capable of understanding, monitoring and, if necessary, intervening.

For this purpose, we brought the setup to multiple international schools in Switzerland over a span of two weeks,

them the goal of the activity, which is to build railroads connecting all the company’s gold mines, distributed in the mountains of Switzerland, by spending as little money as possible as the company has a limited budget (hence, solving a “Minimum Spanning Tree” problem), and illustrates how they can interact with the setup. After the signal “Are you ready? Let’s go!”, the children are assigned two roles, with one of them drawing and erasing tracks while the other reasons about the moves based on

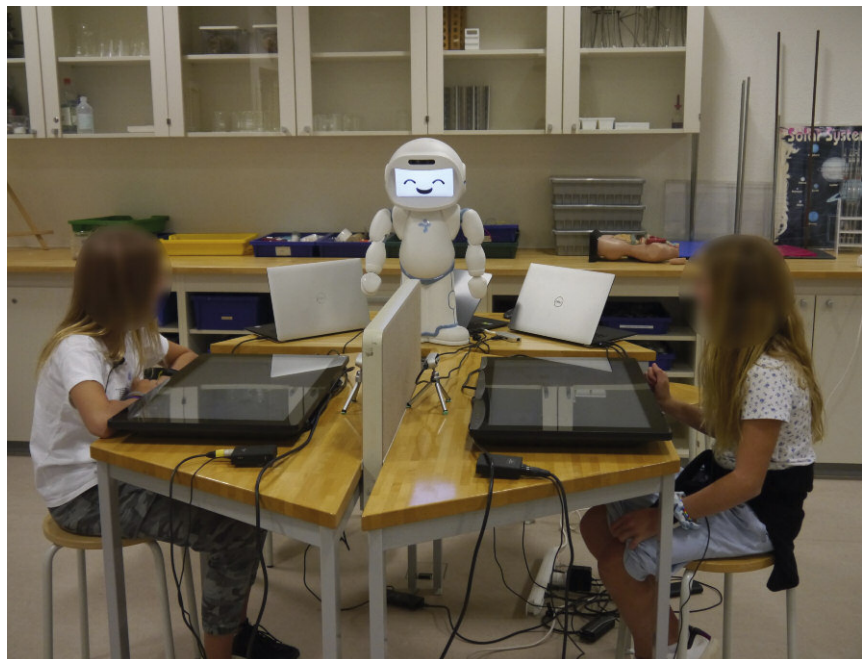

Figure 1: QTrobot welcomes children to the activity.

where around 100 children (age: $M = 10.5$, $SD = 1.36$; median = 10) participated in pairs to have a one hour interaction with the setup.

Children in pairs are welcomed to a setup as in Figure 1 by the QTrobot as the CEO of a gold-mining company looking to hire. After the robot’s welcome, the children introduce themselves to the robot and individually solve a brief test. Then, the robot tells

the costs shown, and the children swap the roles every two moves. Once they agree on a solution, children submit it to the robot CEO, that, in addition to giving them basic guidance and encouragement, tells them how close their solution is to the best possible solution. The collaborative turn-taking design, with a barrier between the children, each of whom always only having partial information, is inspired by two hypotheses: (i) partial information scaffolded

folds towards collaboration when there is a shared goal, and (ii) justifying past and future moves verbally to self/partner based on cost can lead to an initial grounding for abstract reasoning.

The children, surprisingly, without exception, reported really enjoying the activity and expressed interest in integrating it within school activities even though they thought it was challenging. In addition to this, they really liked their robot CEO and found it to be knowledgeable, helpful and friendly.

For us as researchers, what now? To help improve the learning outcomes in this context of human-human-robot interaction, this user study and the multi-modal data collection is just the

beginning. We aim to extract relevant behaviours from the data generated (logs from the apps, facial and lateral videos, audio) and relate it to learning to explore models of engagement and mutual modelling in collaboration with Sorbonne University and Télécom Paris in France. Eventually, the generated models would lead to adapting the robot behaviour effectively in real time to advance learning as well as have appropriate human-human-robot interaction in educational contexts so that the next time we go to schools, we are one step closer to “Educational Technologies for the Future”.

Moral of the story: Children are more accepting of challenging educational activities than we think.

Links:

- [L1] <https://kwz.me/hEM>
- [L2] <https://kwz.me/hER>
- [L3] <http://www.animatas.eu/>

References:

- [1] J. Nasir, U. Norman, et al.: “Robot Analytics: What Do Human-Robot Interaction Traces Tell Us About Learning?,” IEEE RO-MAN 2019 Conference, 2019.

Please contact:

Jauwairia Nasir
EPFL, Switzerland
jauwairia.nasir@epfl.ch

Utku Norman
EPFL, Switzerland
utku.norman@epfl.ch

Gestures in Tangible User Interfaces

by Dimitra Anastasiou and Eric Ras (Luxembourg Institute of Science and Technology)

2D gestures have been extensively examined on surface and interactive tabletop computing, both in the context of training of predefined datasets and “in the wild”. The same cannot be said for 3D gestures, however. The current literature does not address what is happening above the tabletop interfaces, nor does it address the semantics.

Ullmer and Ishii describe tangible user interfaces as giving “physical form to digital information, employing physical artifacts both as ‘representations’ and ‘controls’ for computational media” [1]. The “Gestures in Tangible User Interfaces” (GETUI) project [L1], coupled 2D and 3D gesture analysis with tangible user interfaces (TUIs) with the aim of achieving technology-based assessment of collaborative problem-solving.

We ran exploratory user studies at two secondary schools in Luxembourg and one in Belgium with 66 pupils. We used the multiuser interactive display MultiTaction MT550 and a Kinect v.2.0 depth sense camera to record 3D data relating to the participants. The participants’ task, presented as a microworld scenario on the MultiTaction device, was to build a power grid by placing and rotating tangible objects or widgets, which represented industrial facilities (coal-fired power plants, wind parks, and solar parks) that produce electricity (Figure 1). The design and development of the microworld scenario was done through the COLlaborative Problem

Solving Environment (COPSE), which is a novel and unique software framework for instantiating microworlds as collaborative problem-solving activities on tangible tabletop interfaces [2].

We used the Kinect camera to explore the behaviour of the participants during the collaborative problem solving. The main problem we experienced with Kinect was user identification. As is common in multi-user environments, users moved frequently in order to explore different parameters on the TUI, with the result that their initial IDs were lost or exchanged, leading to misinterpretation of the logging data. Also, the lightening and position of the Kinect had to be selected carefully. An additional technical limitation is recognition of finger-based gestures, including emblems (substitutes for words) and adaptors (gestures without conscious awareness used to manage our feelings). Another research-related drawback is the definition of a gesture and particularly of cooperative gestures. When exactly does a gesture start and when does it end? A gesture usually passes through up to five phases: prepa-

ration, prestroke hold, the stroke itself, poststroke hold, and retraction [3]. In our TUI setting, the most prominent gesture type is pointing. What if, during the poststroke hold of a user A, user B is in the preparation phase of her own gesture? We consider cooperative gesture as a gesture sequence when two or more gestures, the first of which is always pointing, are performed simultaneously or consecutively by multiple users (not by the same user). However, the impact of the cooperative gesture has to be annotated manually, since it can be positive, negative, or none.

The 2D gestures, i.e., gestures performed on the tabletop, are logged by the COPSE software. We decided to develop an application to link the COPSE with Kinect, so that all performed gestures, both 2D and 3D are logged. Therefore, our application consists of two components: i) the Client Reader (COPSE), which reads and transfers information about the object ID and the TUI’s coordinates of the objects, and ii) the Body Reader, which receives these coordinates and converts them into Kinect coordinates by using a



Figure 1: Microworld scenario on the TUI.

transformation matrix (see Figure 2). This matrix is created by the calibration procedure, where the TUI location and its plane are transformed into the Kinect coordinates system. More information is available in a technical report [L2].

The analysis and evaluation of gestures is important both economically and socially, with many fields using gesture as input or output in their applications for instance, telecommunications, entertainment, and healthcare. Nonverbal behaviour is of particular importance in collaborative and virtual environments. Until now, few studies have addressed the nonverbal cues people display in collaborative virtual environments.

With the GETUI project we examined correlations between 3D gestures and collaborative problem-solving performance using a TUI. We compared two groups (high-achievers vs. low-achievers) and found that the pointing gestures were almost equal among the two groups ($M = 25.7$ for low-achievers and $M = 25.6$ for high-achievers), while the adaptors (head/mouth scratching, nail biting) were used slightly more frequently by the low-achievers, whereas the emblems (thumbs up, victory sign) were used largely by high-achievers. We addressed and measured collaboration as one of the transversal skills of the 21st Century. TUIs and the visualisation of microworld scenarios can be used both for formal school education

and assessment as well as for vocational training and modern workplace learning. Today, in group settings, it is not only the group problem-solving performance that matters, but also soft skills, which include personal, social, and methodical competences. In the future, we plan to apply the assets of GETUI to collaborative virtual environments, in order to create and assess avatars' nonverbal behaviour.

Links:

- [L1] <https://kwz.me/hKK>
- [L2] <https://kwz.me/hKS>

References:

- [1] B. Ullmer, H. Ishii, H.: "Emerging Frameworks for Tangible User Interfaces", IBM Syst. J. 39, 915-931, 2000
- [2] V. Maquil, et al.: "COPSE: Rapidly instantiating problem solving activities based on tangible tabletop interfaces", in Proc. of the ACM on Human-Computer Interaction 1(1), 6, 2017
- [3] D. McNeill: "Hand and mind: What gestures reveal about thought" Chicago: University of Chicago Press, 1992.

Please contact:

Dimitra Anastasiou
 Luxembourg Institute of Science and Technology, Luxembourg
 Dimitra.anastasiou@list.lu

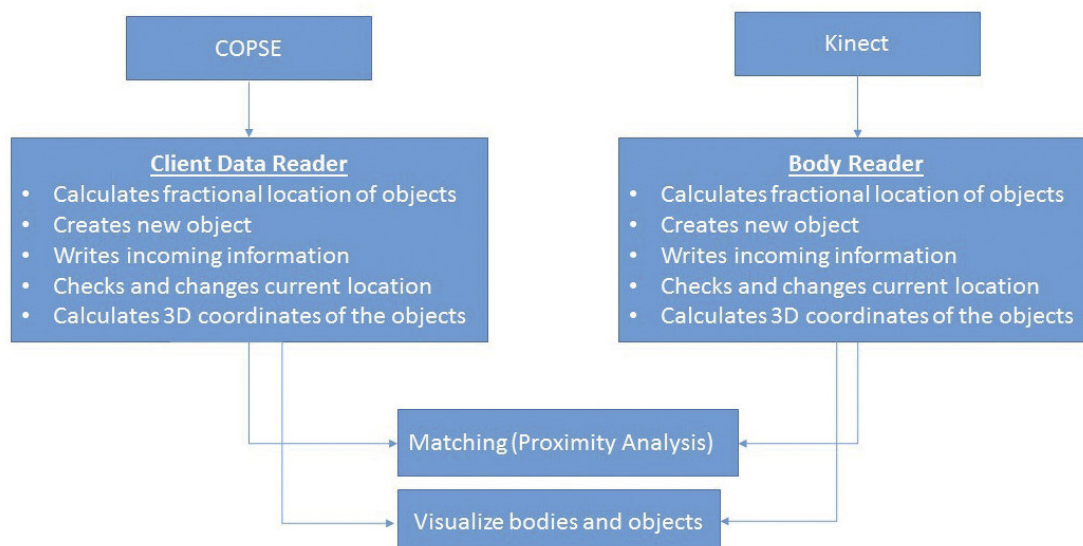

Figure 2: Application linking the recognition of 2D and 3D gestures.

Kniwwelino: A Microcontroller-based Platform Introducing Children to Programming and Electronics

by Valérie Maquil and Christian Moll (Luxembourg Institute of Science and Technology)

The Luxembourg Institute of Science and Technology (LIST) has developed Kniwwelino, a microcontroller-based development platform that uses a visual programming interface to help children discover programming and electronics in a creative and hands-on approach.

Computational thinking skills are considered fundamental for our future daily lives. One approach to foster these skills is to introduce primary school children to programming and electronics through platforms that are easy to use, engaging and fun. Kniwwelino® [L1][1] is a platform that teaches computational thinking in a way that is attractive and interesting to children, while being accessible and easy to use.

Kniwwelino is a microcontroller-based learning environment consisting of a set of printed circuit boards (PCBs), an Arduino Library and a visual programming interface. The main PCB, the Kniwwelino board, proposes a 5×5 LEDs matrix, an RGB LED and two push buttons (see Figure 1). The microcontroller has Wi-Fi connectivity, enabling several boards to connect over the internet. Additional PCBs can be

used as extensions and include different sensors and actuators, such as an LED, a buzzer, a potentiometer, an ultrasonic distance sensor, a touch button, or a temperature sensor. They can be connected to the main board via alligator clips or other types of wires.

To program the hardware, a Kniwwelino Library [L2] is available as well as a visual programming interface [L3] (see Figure 2) accessible via the web browser. In this interface, pieces of code are represented by blocks and users can assemble their programs using drag and drop, like the pieces of a puzzle.

The firmware is distributed to the Kniwwelino board wirelessly via WiFi. This has the advantage that no installation of drivers or software is required and any type of device (laptop, desktop and tablet) and operating system can be used.

Kniwwelino provides a creative and hands-on approach to programming and electronics. Children can rebuild, customise and invent a variety of projects combining technological with non-technological components. Example projects include a wristband to send messages and icons to friends or a weather station that shows current weather conditions available on the internet.

Kniwwelino was developed in an iterative, user-centric design approach, building upon results from previous work and taking in account current technologies available on the market. Throughout its development, Kniwwelino was tested with more than 2,000 children who attended workshops organised at different fairs. Participants provided feedback via a short questionnaire.

The Kniwwelino workshops were equally attended by girls and boys, the majority of whom had never coded before. Most participants found the

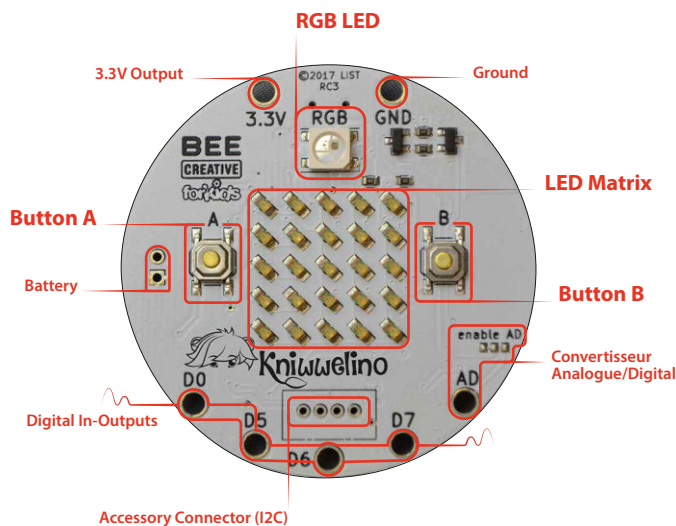

Figure 1: The Kniwwelino board contains a 5×5 LEDs matrix, an RGB LED, two push buttons and several pins for connecting additional hardware.



Figure 2: In the visual programming interface, users can assemble their programs using drag and drop, like the pieces of a puzzle.

Kniwwelino workshops very fun and the included tasks relatively easy. They would like to use Kniwwelino again and to try other programming tools.

Currently, LIST is collaborating with seven primary and secondary schools in Luxembourg to evaluate the feasibility of using Kniwwelino in the Luxembourg's classrooms. Every pilot school was provided with a classroom kit containing in total 15 pupil boxes, each including a Kniwwelino board, 14 different extensions, and cables to connect them. They also received a handbook with pedagogical activities, projects to build and creative material to support pupils in developing new projects. Over the coming months, teachers

will test these materials in their classrooms and document their impressions and experiences.

Kniwwelino was developed by the Luxembourg Institute of Science and Technology (LIST) in collaboration with the National Youth Service (Service National de la Jeunesse – SNJ), a government organisation in charge of non-formal education in Luxembourg, as well as SCRIPT, a government organisation responsible for formal education. The project is supported by the Luxembourg National Research Fund (FNR) under the PSP Flagship (2016-2019) and Jump POC (2019-2020) schemes.

Links:

- [L1] <https://www.kniwwelino.lu/>
- [L2] <https://github.com/kniwwelino>
- [L3] <https://code.kniwwelino.lu>

Reference:

- [1] V. Maquil, et al.: “Kniwwelino: A Lightweight and WiFi Enabled Prototyping Platform for Children”, in Proc. of the 12th International Conference on Tangible, Embedded, and Embodied Interaction, pp. 94-100, ACM, 2018.

Please contact:

Valérie Maquil
Luxembourg Institute of Science and Technology, Luxembourg
valerie.maquil@list.lu

Virtual Simulation Environment for Medical Training

by Thomas Luiz, Dieter Lerner, Dominik Schnier (Fraunhofer IESE)

Virtual Realities (VR) are increasingly used as a simulation technology in emergency medicine education and training. In the project EPICSAVE, a highly immersive room-scaled multi-user 3D virtual simulation environment was developed for medical training scenarios. This enables a realistic and sustainable training experience.

Working in emergency medicine is characterised by constraints that constitute a high-risk constellation: need for situational assessment and decision-making as well as initiation of appropriate emergency measures under time pressure, often under adverse external conditions, and, at the same time, with little or no fault tolerance. Virtual realities (VR) are increasingly used as a simulation technology in emergency medicine education and training, in particular for the training of “non-technical” skills (clinical and procedural reasoning) and teamwork skills. Experimental studies have demonstrated that VR is equivalent, or even superior, to traditional training media (i.e., patient actors or manikins) for training purposes.

In the project EPICSAVE, a highly immersive room-scaled multi-user 3D virtual simulation environment was developed for medical training scenarios. This project involved an interdisciplinary consortium incorporating expertise from all relevant disciplines, i.e., paramedic training academies, medical and media education, media design

research, and production of virtual 3D learning environments. Following a two-year interdisciplinary and iterative development and evaluation process, the second prototype of the virtual simulation environment now consists of different virtual emergency locations with integrated virtual patients of different age groups [L1]. The virtual environment contains more than 60 virtual objects, e.g., interactively usable virtual instruments for the diagnosis and therapy of the virtual patient:

- Change of posture and undressing of the virtual patient
- Monitor-based measurement, e.g., electrocardiogram, blood pressure
- Clinical examination, e.g., breathing sounds
- Medical treatment, e.g., administration of oxygen, application of infusions.

The hardware equipment for a team training with two trainees consists of two VR head-mounted displays (HTC Vive®), four input devices (HTC Controller®), and two computers with display, which are used by the trainers

to control the simulation and follow the training. The trainees and their interactions are transmitted to the VR in real time by means of a motion-tracking system. In the VR, the trainees are represented by avatars. This enables collaborative activities connecting the real world with the VR (e. g., handing over medical equipment). The VR system automatically records the training sessions and documents important diagnostic steps or therapeutic interventions [1]. The virtual patient represents a multitude of pathological parameters and symptom characteristics:

- Psychomotor condition
- Different states of consciousness
- Breathing sounds
- Pulse frequency and strength
- Cyanosis, blue coloration of the skin.

This goes beyond the current capabilities of commercially available, costly high-fidelity simulators or patient actors. The EPICSAVE virtual simulation environment enables the realistic treatment of complex, dynamic, and rare emergencies without compromising real patients (see Figure 1).



Figure 1: The virtual patient in the virtual simulation environment, (source: TriCAT GmbH, Ulm).

The highly immersive VR has made possible a dynamically changeable, realistic, and three-dimensional visualisation of different clinical environments and patients from different perspectives [2]. This enables spatial positioning of the trainees in the virtual 3D emergency environment and fosters the feeling of being present in this scenario. A high level of presence experience correlates positively with variables for learning or training effectiveness. Furthermore, a high degree of realism increases the likelihood that the learning experiences will be transferred to real environments. As part of the project, the virtual simulation environment was evaluated with five study groups. The following parameters were measured during each training session: presence experience, usability, cyber sickness, assessment of training effectiveness, cognitive load, current learning motivation, and up-to-date knowledge of the respective emergency scenario. The participants of the five studies rated the VR simulation

training above average in terms of training effectiveness, quality of training execution, and potential for improving motivation and immersion [3].

The EPICSAVE VR will continue to be developed even after the project has ended. In the follow-up BMBF project ViTAWiN (Virtuell-augmentiertes Training für die Aus- und Weiterbildung in der interprofessionellen Notfallversorgung [Virtual-augmented training for education in interprofessional emergency care], FKZ 01PV18006), mixed-reality technologies are now being combined with VR. The ViTAWiN approach pursues the goal of expanding VR through the integration of haptic input and output devices, such as augmented virtuality (AV). Thus, the previous potential of training and learning in VR (non-technical skills) can be extended to the training of technical skills. In addition to this realistic and three-dimensional visualisation, a perceptualisation of virtual objects (virtual patient, virtual

equipment) can also be achieved. The learning- and training-relevant contents in the VR will be presented to the trainees using means of visual, auditory, and haptic-tactile interaction [L2].

The project EPICSAVE (Enhanced Paramedic vocational training with Serious games And Virtual Environments) was funded by the German Federal Ministry of Education and Research (BMBF) and the European Social Fund of the European Union (EFS) (duration: 03/2016-02/2019, FKZ 01PD15004).

Links:

[L1] <https://www.epicsave.de>

[L2] <https://www.vitawin.info>

References:

- [1] J. Schild, et al.: “EPICSAVE – Enhancing Vocational Training for Paramedics with Multi-user Virtual Reality”, in IEEE SeGAH, pp. 1–18, 2018. DOI: 10.1109/SeGAH.2018.8401353.
- [2] D. Lerner, T. Luiz: “Close to reality. Learning with virtual patients” [Nah an der Realität. Lernen mit virtuellen Patienten], *Intensiv 27* (2), 64–69, 2019. DOI: 10.1055/a-0821-3183
- [3] D. Lerner, D. Wichmann, K. Wegener: “Virtual reality simulation training in emergency paramedic training” [Virtual-Reality-Simulationstraining in der Notfallsanitäterausbildung], *retten!* 2019; 8(04), 234–237. DOI: 10.1055/a-0820-8614

Please contact:

Dieter Lerner
Fraunhofer IESE, Germany
Research Program Healthcare
dieter.lerner@iese.fraunhofer.de

Mixed Reality and Wearables in Industrial Training

by Ralf Klamma (RWTH Aachen University), István Koren (RWTH Aachen University) and Matthias Jarke (Fraunhofer FIT and RWTH Aachen University)

The Horizon 2020 project WEKIT has created an industrial training platform, combining sensor technologies, artificial intelligence and mixed reality. The platform creates training materials on the fly and delivers them in a standardised manner.

With digitisation of workplaces impacting many professions, industrial training needs to adapt accordingly.

Wearables show enormous potential to help in this space, and we envisage three major shifts taking place. First,

industrial training often includes training in manual labour processes. Quantitative digital ethnography based

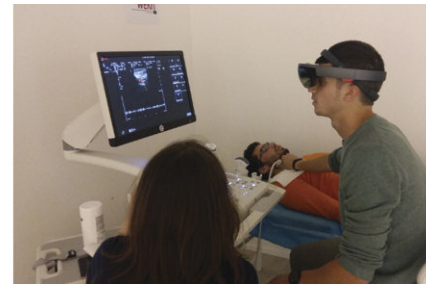

Figure 1: Scenarios from the WEKIT project © WEKIT and Mikhail Fominykh.

on big data from wearable devices could foster an understanding of these processes in digital workplaces. Second, once the big data are acquired, automated analysis will be needed. To achieve this, artificial intelligence and machine learning will enter industrial training. Finally, the interface between humans and machines will move away from flat computer screens to more immersive forms of feedback in artificial spaces in mixed reality environments.

The European H2020 project WEKIT (Wearable Experience for Knowledge Intensive Training, 2015-2019) aims to introduce wearables into industrial training scenarios. The project addresses three scenarios, displayed in Figure 1: ground training for astronauts, training for aircraft maintenance personnel in arctic rescue missions and training of medical personnel in the use of 4D ultrasound diagnostic devices.

From a technical perspective, the main outcome of the project is the WEKIT.ONE platform [1]. The platform consists of a self-developed hardware component: a bank of sensors in a self-designed vest with an electronic board (PCB), connected to a MS HoloLens and more sensors in mobile phones and arm wrists.

The hardware is connected to a recorder and a player. The recorder enables the creation of learning materials by recording the sensor data of experts executing procedures for the training scenarios. The data are stored in a database and analysed by the WEKIT.ONE software. The player recognises the training situation either automatically or as instructed by a trainer. Subsequently, the player supports the training through a number of environmental augmentations, such as virtual traces on the ground leading from one station to the next, or by “ghost hands”

indicating the manipulation of devices like the cutting of a wire through the use of an augmented head-mounted device.

As a pedagogical innovation, WEKIT has developed a new instructional design model. Tasks, support information, procedural (manual) knowledge and practices have been categorised for use within the platform. In this context, WEKIT has been addressing the question of how we can describe, store, retrieve and exchange training scenarios together with necessary contextual information in a standardised way. An IEEE-SA working group has begun the standardisation of our Augmented Reality Learning Experience Model (ARLEM). An open-source model editor is available at [L1]. Public project deliverables are available on the website [L2] and a start-up company WEKIT ECS (Experience Capturing Solutions) [L3] is exploiting the results.

This new field of learning with wearable technologies is thoroughly explored in a new book published by Springer [2]. The interface between humans and machines moves away from traditional cognitive tools, just as we moved from typewriters to digital thinking tools. Humans are increasingly interacting with machines, and technology is increasingly being used in training scenarios [3]. Data fusion and artificial intelligence can bring together data from heterogeneous sources, helping us to recognise human activities in both human-human and human-robot collaboration scenarios. By making the analytical results available in mixed reality spaces, training, analytics and interventions can take place within the same space without the media breaks and loss of context that occur in traditional training.

New forms of sensor data fusion and processing, including big data visual analytics, are enabling innovative

research into the changing workplace. In conducting this research, data protection, privacy, ethical considerations and adherence to workplace legislation must have the highest priority. Like any new technology, these tools have the potential to be misused, and a broad social acceptance is key to their success.

Links:

[L1] <https://kwz.me/hEA>

[L2] <http://wekit.eu/>

[L3] <https://wekit-ecs.com>

References:

- [1] B. Limbu et al.: “WEKIT.One: A Sensor-Based Augmented Reality System for Experience Capture and Re-enactment,” in LNCS, Transforming Learning with Meaningful Technologies, M. Scheffel, et al., Eds., Springer, 2019, pp. 158–171.
- [2] I. Buchem, R. Klamma, F. Wild: “Perspectives on Wearable Enhanced Learning (WELL): Current Trends, Research, and Practice”. Cham, Switzerland: Springer Nature Switzerland AG, 2019.
- [3] R. Klamma, R. Ali, and I. Koren: “Immersive Community Analytics for Wearable Enhanced Learning,” in LNCS, Learning and Collaboration Technologies. Ubiquitous and Virtual Environments for Learning and Collaboration, P. Zaphiris and A. Ioannou, Eds., Springer, 2019, pp. 162–174.

Please contact:

Ralf Klamma

RWTH Aachen University, Germany

klamma@dbis.rwth-aachen.de

Personalized Interactive Edutainment in Extended Reality (XR) Laboratories

by Aris S. Lalos (ISI, ATHENA R.C.), Chairi Kiourt (ILSP, ATHENA R.C.), Dimitrios Kalles (Hellenic Open University) and Athanasios Kalogeras (ISI, ATHENA R.C.)

XR-LAB envisages developing a highly innovative & interactive extended reality (XR) platform that will empower users, including educators and trainees, to create easily accessible and sustainable edutainment experiences. This will be achieved using holographic interfaces and gamified elements that will develop gradually as familiarity with interactive features is gained. The proposed approach is expected to create convenient, safe, economic, rapid, flexible and user-friendly spaced educational tools that challenge, engage and prepare students for their real scientific experiment in remote STEM education laboratories.

Mixed-reality allows the merging of physical and virtual worlds, creating environments where physical and digital objects co-exist and interact in real-time. It has been used in areas ranging from entertainment and health applications to military training. Extended reality (XR) is defined as a form of mixed reality environment that comes from the fusion of ubiquitous sensor/actuator networks and shared online virtual worlds, to encompass all the possibilities of reality warping technology. Statista reported that social media (i.e., Facebook) had 1.49 billion monthly active users in the second quarter of 2015. Imagine edutainment environments so engaging that people could stay in them for hours and never tire of them! This is where XR comes into the picture.

The role of future XR interactive systems in edutainment

As an emerging technology, virtual, augmented and mixed reality (XR) not only supplements the dynamic notion of the instructional practices but also incorporates sensory modalities, such as, touch, sight and hearing. Several studies reveal the potential benefits of

XR in educational contexts, including improving the user’s level of achievement, motivation, knowledge retention and engagement. This technology can also guide targeted behaviour change to improve the way that various activities are undertaken so that the user begins to take the desired actions in different contexts whilst deriving more enjoyment from their tasks [3]. XR technologies are breathing life into the notion that edutainment can be accomplished anywhere; not just within the confines of a classroom. XR is undoubtedly poised to change the way users deliver and acquire information, knowledge, and skills, in playful learning environments [1]. This is bolstered by the rise in popularity of VR and AR devices in Europe, with sales in Western Europe reaching an impressive 283 thousand units of VR/AR head-mounted displays in the second quarter of 2016. According to a recent report published by Allied Market Research, the global mixed reality market was valued at \$123.2 million in 2017, and is projected to reach at \$5,362.1 million by 2024, growing at a CAGR of 71.6% from 2018 to 2024.

XR technologies in education

Motivation to learn is a complex process, and what motivates on student may not motivate another. Recent studies have shown that personalised edutainment systems improve motivation: students respond favourably to flexible or reduced training/studying hours, course adjustments, or part-time studying and autonomy – all of which are primary areas of intervention for personalised systems [2]. However, we don’t currently know what role these systems play in motivating students to spend more hours acquiring an understanding of complex concepts using laboratory equipment where layouts and modalities are more potent. While multisensorial collaborative edutainment systems hold great potential to improve the interventional aspects of education, very few such systems are used to teach scientific concepts. This means that current interventional “devices” (e.g. virtual assistants, physics based XR interactions and cognitive aware visual analytics) in personalised systems could have both positive and negative educational effects, which, at best, reduces their potential impact (e.g., to induce

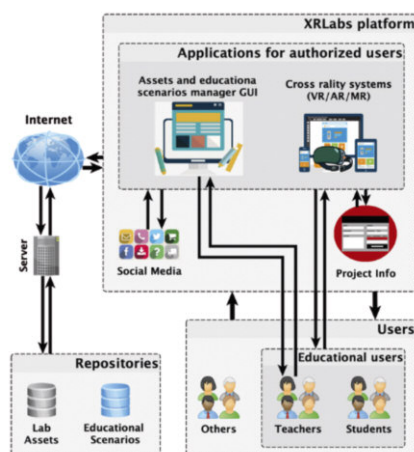

Figure 1: XRLabs conceptual architecture.

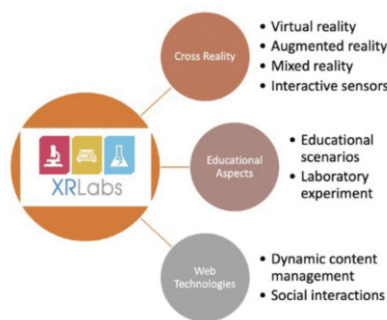

Figure 2: XRLabs cutting-edge technologies.



Figure 3: Interaction with VR environment with motion sensing controllers.

real knowledge acquisition) and, at worst, might lead to rebound effects (e.g. ironic effects, poor understanding due to information overload or over-trust). If these personalised edutainment systems are to be effective, they undoubtedly require smart incentive mechanisms that offer higher quality experiences, motivating users to engage in creative activities.

The XRLab case

The XRLab is a platform focusing on modern education based on student-centred educational systems with dynamic content, which is not affected by geographical, financial and time constraints, in the way that conventional educational methods are. The proposed platform focuses on laboratory training for all levels of education. Within this framework, the systems under development are based on cutting-edge technologies, such as interactive virtual, augmented and mixed reality environments. The XRLab platform combines three main research areas of Semantic Web, namely: knowledge management in education, gamification and educational systems. Figure 1 depicts the main architecture of the XRLab platform. According the main structure graph, all users (authenticated or not) have basic access (limited) to the systems of the platform. Authenticated users, such as students and teachers, are associated with their status and are given additional services. The main

structure of the XRLab includes cutting-edge technologies/methodologies, shown also in Figure 2, focusing on the development of a user-friendly educational environment. An example of the XRLab platform equipped with motion sensing controllers is shown in Figure 3, where students interact with the dynamic object of a virtual laboratory. XRLab follows a user-centred design approach, designing and evaluating the project developments and the overall, integrated XRLab system in realistic conditions in Hellenic Open University. Our main objective during the evaluation phase is to investigate whether students who use the XRLab as a supplement to traditional learning methods learn scientific concepts and experimental skills more easily or if they are cognitively overloaded by the large amount of information, the multiple technological devices, and the complex tasks they have to deal with. The impact of such a holistic approach is huge and the foundations laid here are expected to result in a widespread adoption of sensor-based XR interaction platforms in a wider range of edutainment contexts.

This work is supported by the project XRLAB - Virtual laboratories using interactive technologies in virtual, mixed and augmented reality environments (MIS 5038608) implemented under the Action for the Strategic Development on the Research and Technological Sector, co-financed by

national funds through the Operational program of Western Greece 2014-2020 and European Union funds (European Regional Development Fund).

Link: <http://XRLab.eu/>

References:

- [1] I. Radu: “Why should my students use AR? A comparative review of the educational impacts of augmented-reality”, in Proc. of IEEE International Symposium on Mixed and Augmented Reality (ISMAR) (pp. 313–314), 2012.
- [2] E. Paxinou, et al.: “A 3D virtual reality laboratory as a supplementary educational preparation tool for a biology course”, European J. of Open, Distance and E-Learning, 2018
- [3] K. Gardelis, A. Lalos, K. Moustakas: “Development of an Eco-Driving Simulation Training System with Natural and Haptic Interaction in Virtual Reality Environments”, in Proc. of the 13th Int. Joint Conf. on Computer Vision, Imaging and Computer Graphics Theory and Applications - Vol. 2: HUCAPP, pp. 94-101, 2018. ISBN 978-989-758-288-2

Please contact:

Aris S. Lalos
ISI, Athena Research Centre, Greece
lalos@isi.gr

Music in Education through Technology

by Maximos Kaliakatsos-Papakostas, Kosmas Kritsis, Vassilis Katsouros (Institute for Language and Speech Processing, Athena Research and Innovation Centre)

Combining Science, Technology, Engineering, Arts and Mathematics (STEAM) into a unified pedagogical framework, enables students to directly identify connections between abstract concepts and elements of the real-world. The iMuSciCA project has made the first steps towards developing tools, methods and lesson plans for stimulating creativity in learning and providing the basis for deeper learning. This is achieved with cross-disciplinary lesson plans implemented through the iMuSciCA workbench: an innovative suite of web-based software tools around STEAM.

The iMuSciCA project [L1] (Interactive Music Science Collaborative Activities) has made a first step towards integrating music into STEM (Science, Technology, Engineering and Mathematics) education. iMuSciCA not only brings arts into the heart of STEM, following the paradigm of STEA(rts)M education, but it also combines pedagogy with innova-

tive technologies. The new method introduced by this project has been designed, applied, tested and, whenever necessary, re-adjusted in a real education setting. To this end, iMuSciCA involved a multi-disciplinary team comprising academics, artists and technology experts who co-developed lesson plans alongside an innovative set

of interactive STEAM educational tools on a unified workbench [L2].

A novel educational approach

STEAM is an educational paradigm that is gaining ground in the European educational system and iMuSciCA is among the first projects to examine in-depth the implications of STEAM in

deeper learning. Until recently, technological education and the arts have been considered as separate subjects, however, bridging the two fields leads to a cross-fertilisation process that benefits learning in both fields. According to the iMuSciCA approach, immense educational dynamics can develop by incorporating creativity, expressed in musical expression and experimentation, in STEM learning environments. In iMuSciCA this is achieved through a web-based workbench [1] that integrates advanced core enabling technologies, including 3D design and printing of musical instruments, body tracking sensors for gesture recognition, interactive pens and tablets as well as sound generation and processing tools.

Various tools have been developed based on the aforementioned technologies that allow users/students to realise and develop connections between and across concepts in music and STEM. This helps students creatively discover laws of physics[2], relations in mathematics and phenomena in engineering and technology. This is achieved by allowing students to move from one field to another with different starting points, practically by changing educational environments inside the workbench, implementing the inquiry-based science education (IBSE) phases, i.e., engage, imagine, create, analyse, communicate and reflect. Some lesson plans have been developed in the context of the iMuSciCA project, but the workbench also enables teachers to be more creative and expressive in their teaching by authoring their own scenarios, leveraging the combined dynamics and the openness of the workbench as well as the ease with which users can jump from one STEAM environment to the other.

Expertise and technologies: a cross-discipline consortium

This multi-facet approach to learning could only be achieved by a consortium comprising partners who not only bring unique expertise but are also in a position to understand and develop ideas and technologies across disciplines. ATHENA Research and Innovation Centre focuses on interaction with 3D technologies, but also has expertise in developing educational as well as music software. The University College at Leuven-Limburg (UCLL) developed the overall pedagogical design and evaluation of the outcome of the entire project.

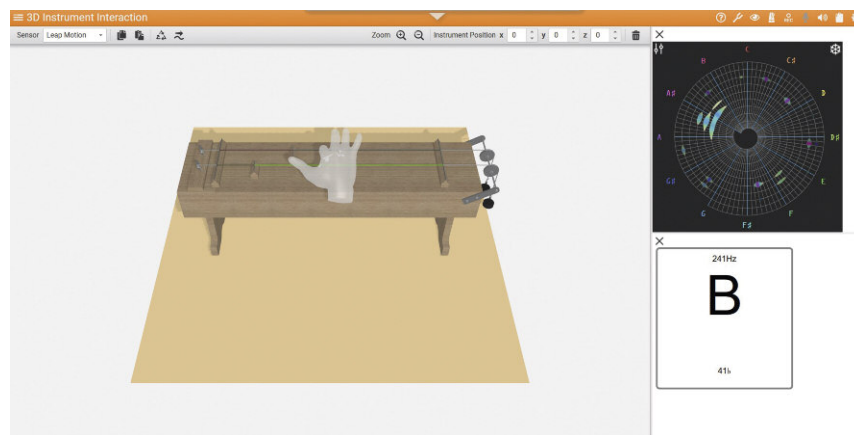

Figure 1: The iMuSciCA cross-disciplinary approach, among many other activities, allows the design of virtual 3D virtual instruments using real-world physical quantities, along with informative visualisations of sound (timbre/harmonics) and music.

Ellinogermaniki Agogi, a private school in Greece, implemented pilot tests and helped in developing lesson plans, involving a multidisciplinary team of teachers (from music to physics). The Institute de Recherche et de Coordination Acoustique Musique (IRCAM) in France developed the real-time sound synthesis algorithm and actuation technology, involving tech experts who are also musicians. Leopoly, a Hungarian SME, contributed with their expertise in 3D interactive object design. Cabrilog from France offered tools for interactive education in mathematics. Spanish WIRIS contributed with their handwriting recognition technologies along with musical tools that took advantage of mathematical formulas and geometric shapes. The University of Fribourg in Switzerland worked on handwriting analysis and workbench integration and, with ATHENA, in deploying biometrics sensors for assessing implications of the iMuSciCA approach in (deeper) learning.

Evaluating the iMuSciCA approach

Research teams in Greece, Belgium and France initially investigated the usability of the iMuSciCA workbench by co-creating lesson plans and educational scenarios with teachers and then conducted pilot studies between November and December 2017. Both teachers and students gave positive feedback along with some comments that were integrated in subsequent versions of the workbench. The final version of the workbench during the time span of the project, included complete localisation with translations on all tools; this, along with the improved usability, allowed for a final pilot testing

in two phases from September 2018 to May 2019, to assess the effect of this approach on deeper learning, without the barrier of the UI being presented in a foreign (to non-English speakers) language. The deeper learning evaluation procedure established by the pedagogical team is based on an approach proposed by the Hewlett Foundation and it was based on questionnaires for students and teachers. The results of this study (currently available on [L2]) indicated that the iMuSciCA approach is effective for facilitating deeper learning. Acceptance of iMuSciCA by teachers seems promising, with teachers' communities forming in the countries involved in the pilot studies.

Links:

- [L1] <http://www.imuscica.eu/>
- [L2] <https://workbench.imuscica.eu/>

References:

- [1] K. Kritsis, et al.: "iMuSciCA: A Web Platform for Science Education Through Music Activities", in Proc. of the Web Audio Conference 2019 (WAC '19). Trondheim, 2019.
- [2] E. Andreotti, R. Frans: "The connection between physics, engineering and music as an example of STEAM education", *Physics Education*, 54, 2009. <http://doi.org/10.5281/zenodo.3358408>

Please contact:

Maximos Kaliakatsos-Papakostas, Vassilis Katsouros, Athena Research and Innovation Centre, Greece
maximos@athenarc.gr,
vsk@athenarc.gr

Dance Education and Digital Technologies

by Katerina El Raheb and Yannis Ioannidis (“Athena” Research and Innovation Center and National and Kapodistrian University of Athens)

WhoLoDancE (Whole-body Interaction Learning for Dance Education), a three-year EU funded project, has developed innovative technologies for dance practice, creation and education, focusing on four dance genres: ballet, contemporary, flamenco, and Greek folk.

The relationship between dance education and new technologies is still immature, but evolution in fields such as motion capture, augmented, mixed and virtual reality, combined with data, information and knowledge representation and analysis, have great potential to benefit the dance education of the future [1].

The WhoLoDancE (Whole-body Interaction Learning for Dance Education) project’s main goal is to design and apply innovative digital education technologies that will benefit the community of dance practitioners, experts, researchers, students, educators, choreographers, as well as the wider community of amateurs and professionals and the interested public.

The project’s objectives can be summarised as: (i) to investigate bodily knowledge by applying technologies such as computational models to automatically extract characteristics that are relevant to both the quantitative and expressive characteristic of movement; (ii) to preserve cultural heritage by creating a motion capture repository of dance motions, with built-in methods allowing enrichment through annotation, segmentation and synthesis, (iii) to develop innovative ways of teaching dance, such as via life-sized visualisation of the body through different avatars in mixed reality - e.g., using HoloLens and sonification of movement; (iv) to revolutionise choreography, by designing and organising an interactive repository of motion capture, providing choreographers and dance teachers a powerful tool to blend and get inspired by an infinite number of dance compositions from different dance traditions; (v) to extend access to and practice of dance, by providing access to the created dance database through commercially available low-end motion capture devices like the MS Kinect, low-cost sensors and wearables.

The project focused on four dance genres that represent different forms of

intangible heritage and / or performing art: ballet, contemporary, flamenco and Greek folk. Each of these genres also presents unique requirements related to movement vocabulary and teaching approach.

A major outcome of the project is the creation of a big database of over 780 curated dance movement sequences that have been recorded using motion capture technologies. A conceptual framework [2] has been proposed to guide the

getting dance educational institutions and wider audience.

WhoLoDancE project, as a collaboration between technology experts, researchers, dance educators, choreographers and artists, used four dance genres as use-cases and a proof-of-concept to open a dialogue on how dance movement can be captured and transmitted to the next generations. In fact, both the outcomes and open issues that have been reported by the project, sug-



Figure 1: Two Greek Folk dancers from Lykeion ton Hellinidon (The Lyceum Club of Greek Women) recorded using optical Motion Capture at Motek Entertainment Studio, for the creation of WhoLoDancE Movement Library.

recording process and develop the user scenarios and requirements for the final whole-body interaction experiences. The resulting toolkit of WhoLoDancE includes a set of web-based tools to analyse, segment, annotate and blend movement as well as interactive experiences that integrate augmented and mixed reality, sonification of movement and visualisation of the human body and movement in different avatars and environments [3]. In addition, several evaluation events and performative workshops have been held throughout Europe (UK, Greece, Italy, Spain) tar-

gest that there is still considerable future work to be done to design the ideal digital educational experience for dance. The process is complicated by the complexity and richness of human movement as well as the diversity and cultural pluralism that is integrated into dance. For example, teaching of Greek folk dance, as a traditional dance form and an important part of cultural heritage, includes much more than the teaching of the movement itself. Every dance is tightly connected with rhythm, lyrics, the location of its origin, the customs, the climate, the costume, the con-

text in which the particular dance is performed and by whom (e.g., elders, men, women), the stories and traditions.

There are huge technical challenges associated with analysing movement, and to address it properly requires a collaborative effort between multiple computer science fields, including motion capture, signal processing, data analytics, semantic technologies, artificial intelligence, human computer interaction, graphics and digital artistic perspectives. The interdisciplinary challenges have proven even greater, and in most cases the design process of a meaningful digital pedagogical tool is a complex constraint satisfaction problem, with conflicting objectives (e.g., making tools that are reusable and scalable vs. identifying and respecting the needs of the particular dance traditions).

Upon completion of the project, most of the partners, including “Athena”

Research and Innovation team will be continuing research into how to make relevant technologies more usable, cost-effective and accessible to a wider audience. As a research team, we will keep investigating effective and meaningful ways to document, represent and transmit dance movement and knowledge.

WhoLoDancE (Whole-body Interaction Learning for Dance Education) is a closed three-year Research and Innovation Action funded under the European Union’s Horizon 2020 Programme that investigates the design and application of digital tools to dance learning and education [L1]. WhoLoDancE is a collaboration between European technology research, educational and intangible cultural heritage institutions with creative industry and dance companies.

Link:

[L1] <http://www.wholodance.eu/>

References:

- [1] K. El Raheb, et al.: “Dance Interactive Learning Systems: A Study on Interaction Workflow and Teaching Approaches”, ACM Computing Surveys (CSUR) 52.3 (2019): 50.
- [2] A. Camurri, et al.: “WhoLoDancE: towards a methodology for selecting motion capture data across different dance learning practice”, in Proc.of the 3rd International Symposium on Movement and Computing. ACM, 2016.
- [3] A. Rizzo, et al.: “WhoLoDancE: Whole-body Interaction Learning for Dance Education”, CIRA@EuroMed. 2018.

Please contact:

Katerina El Raheb,
National and Kapodistrian University of Athens, Greece,
kelraheb@di.uoa.gr, +302107275188

Intelligent Classroom: Materialising the Vision of Ambient Intelligence for Education

by Asterios Leonidis, Maria Korozi, Margherita Antona and Constantine Stephanidis (FORTH-ICS)

The ICS-FORTH Ambient Intelligence (AmI) Programme is a long-term horizontal interdisciplinary RTD Programme aiming to develop pioneering human-centric intelligent technologies and environments that seamlessly support everyday human activities and enhance well-being through human-technology symbiosis.

Acknowledging the omnipotent impact of technology on the domain of education, we have pursued the vision of a student-oriented and educator-friendly “Intelligent Classroom” that supports students in their journey to acquiring knowledge. The classroom simulation space [R1] located within the AmI Facility [L1] provides an ideal testbed for assessing the effects of intelligent technologies on key aspects of the educational process. Designing and developing ambient applications that shape the “Intelligent Classroom” is an ongoing activity and an open research endeavour, integrating and assessing emerging technologies that introduce new educational opportunities and interaction paradigms.

More specifically, the hardware infrastructure includes both commercial and custom-made artefacts, which are

embedded in traditional classroom equipment and furniture, while various ambient facilities are also available for monitoring the overall environment and the learners’ activities. One of the key classroom artefacts, the “Smart Student Desk”, has been drastically re-designed since its first realisation in 2010, when it featured a vision-based back-projected multi-touch screen. Now, the desk artefact features a more appealing and ergonomic design, embedding a 24-inch wide, all-in-one computer, secured in a rotatable steel frame. At the same time, the next version of the student desk is already under development, featuring a modular design, where customisable surfaces can be added or removed on demand, in order to support the specific needs of each course. This new generation desk will further enhance students’ engagement and motivation, offering hands-on experi-

ence and providing personal study spaces with specialised equipment.

The design process of the classroom board followed a course similar to that of the students’ desk. The first version of the “Intelligent Classroom Board” featured a commercially available interactive white board, while the second version used a 70-inch, 4K TV along with a multi-touch panel in order to enable collaboration and increase the interactive area. Following the recent advances in projection technologies, which can transform plain walls into interactive displays, the current version of the classroom board extends beyond digital devices; two out of the four walls of the “Intelligent Classroom” (i.e., the wall in front of the entire class and one side wall) act as interactive smart boards, where educational content (e.g., multimedia, notes, exercises) can be



Figure 1: 3D representation of the “Intelligent Classroom” displaying the “Smart Student Desk”, the “Intelligent Classroom Board” and the “Teacher Workstation”.

presented, while they are also used to create attractive, situational (i.e., course-, topic- and discussion-specific) environments, where students can be immersed into an “environment” (e.g., a cave or a rainforest). Finally, the design of the “Teacher Workstation” has shifted away from the traditional desk and now enables educators to monitor and manipulate every aspect of the “Intelligent Classroom” (e.g., ambient facilities, educational software, intelligent behaviour, automations) from a comfortable technologically-augmented armchair.

The underlying software of the “Intelligent Classroom” has evolved gradually over the years and has now reached a satisfactory level of maturity, creating a unified environment that promotes teaching and learning. In particular, the ClassMATE and the AmI-Solertis [R2] frameworks support fundamental services, such as interoperability of heterogeneous intelligent services, synchronous and event-based communication, resilience, security, etc. Additionally, they empower contextual awareness, thus enabling the classroom to immediately respond and orchestrate the available intelligent artefacts (e.g., boards, desks, walls) in order to effectively and efficiently address the needs of students and educators. Furthermore, such infrastructure

features an adaptive content retrieval mechanism and a learners’ behaviour knowledge library, to enable the intelligent environment to personalise the educational content to each student’s actual learning needs. Additionally, the classroom features LECTOR [R3], an educator-oriented platform that helps identify behaviours that require remedial actions (e.g., student is not paying attention) and deliver appropriate interventions when students and teachers need assistance (e.g., a motivational cue to encourage participation, a suggestion to adjust the current pedagogical approach in order to re-engage students). As far as the end-user applications are concerned, CognitOS is a web-based window manager that hosts educational applications and instantiates a common “Look-n-Feel” across the various classroom artefacts, thus transforming the classroom into a unified environment, rather than a group of isolated units. On top of that, CognitOS features mechanisms that enable the initiation of interventions dictated by LECTOR in order to: (i) attract the educator’s attention in problematic situations, and (ii) re-engage distracted or unmotivated students in the educational process.

Up until now, many ambient applications (e.g., teaching Greek as a foreign language, independent living skills

training for children with cognitive disabilities) and educational games (e.g., geography game, spelling game) have been implemented for the “Intelligent Classroom”. These applications have been tested through formal evaluation experiments, while dozens of demonstrations offered to visitors of the “Intelligent Classroom” have given the opportunity for informal evaluations. Our future plans include multiple, in-vitro, summative, user-based evaluation experiments with educators and students, in order to assess the effectiveness of each system, as well as the classroom environment as a whole.

Link:

[L1] <http://ami.ics.forth.gr>

References:

- [1] M Korozi, et al.: “ Shaping the Intelligent Classroom of the Future”. In C. Stephanidis & M. Antona (Eds.), HCI International 2019 – Late Breaking Posters, Vol. 37 of the combined Proceedings of HCI International 2019, Orlando, FL, USA, y (pp. 200-212). Springer, 2019
- [2] A. Leonidis, et al.: “The AmI-Solertis System: Creating User Experiences in Smart Environments”, in Proc. of PerCAM 17, in the context of the WiMob 2017, Rome, Italy (pp. 151-158), 2017
- [3] M. Korozi, et al.: “Lector: Towards Reengaging Students in the Educational Process inside Smart Classrooms”, in P. Horain, et al. (Eds.), Intelligent Human Computer Interaction, Proc. of IHCI 2017, Evry, France (pp. 137-149). Springer, LNCS 10688, 2017

Please contact:

Constantine Stephanidis
FORTH-ICS, Greece
+30 2810 391741
cs@ics.forth.gr

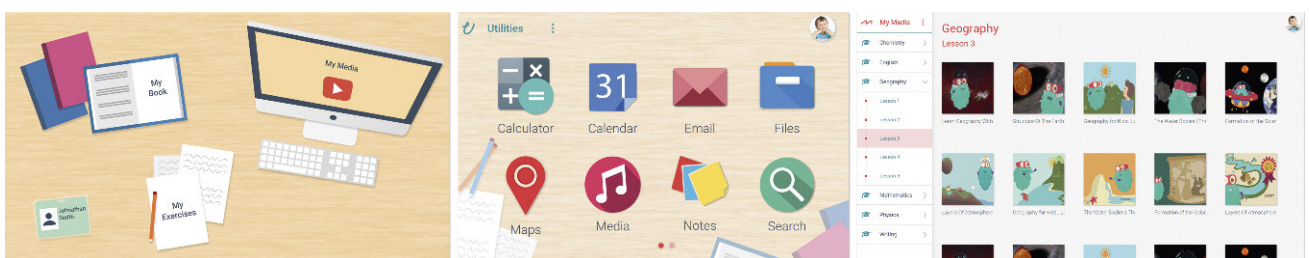

Figure 2: Snapshots of CognitOS dashboards and multimedia application running on the “Smart Student Desk”.

Innovative Monitoring of Learning Habits and Motivation in Undergraduate Mathematics Education

by Brigitta Szilágyi (Budapest University of Technology and Economics), Szabolcs Berezvai (Budapest University of Technology and Economics) and Daniel Horvath (EduBase Online Ltd.)

The Educational platform EduBase ensures continuous testing opportunities and analyses the learning behaviour and performance of undergraduate engineering students in a mathematics course. Compared to the conventional method, students using EduBase were found to be more motivated to practice consistently throughout the semester and acquire deeper level of knowledge.

Testing in education has traditionally been a process of checking and evaluating students' knowledge - generally with exams. Testing can also serve as a learning tool, however, with information being retrieved but not recorded. Testing is known to have long term learning benefits, although there is no consensus about the mechanism by which the "testing effect" operates. Some studies assume that retrieving a particular piece of information from our memory also activates notions associated with it [1]. Others suggest that recalling strengthens the memory imprint corresponding to a given piece of information [2].

Regular testing also encourages students to learn continuously instead of "cramming", giving them frequent feedback

relies on conceptual ways of thinking and abstract concepts. Furthermore, it is extremely difficult to test theoretical hypotheses and the results of pilot studies in real-life using conventional tools, as it is almost impossible to carry out experiments over a large sample (hundreds of students) and over a longer period (e.g., a whole semester). Consequently, a novel tool is required to monitor students' learning behaviour and testing performance.

In this study, we focused on a first-year undergraduate mathematics course (Calculus 1) for engineers at Budapest University of Technology and Economics. Calculus 1 is one of the most important basic subjects in the curricula of engineering programmes, in which

EduBase Classroom [L1], a cloud-based educational platform developed by the members and students of our mathematics methodology group (the workflow of our methodology is illustrated in Figure 1). EduBase is a device and platform-independent learning-management system (LMS) providing a customisable teaching and testing interface that covers a wide spectrum of examinations (e.g., homework, tests, and exams), which can be managed via a digital classroom. The test system of EduBase was developed for mathematical testing in which parametrised tasks, function evaluations, vector and matrix formulations are also implemented. The quizzing system also provides continuous data on learning performance, enabling the tutors to continuously monitor learning performance and progress during the semester, which is not possible with traditional methods of teaching. The EduBase Test System is proving to be an excellent tool not only for online education and motivation but also for scientific research in the fields of cognitive sciences and teaching methodology.

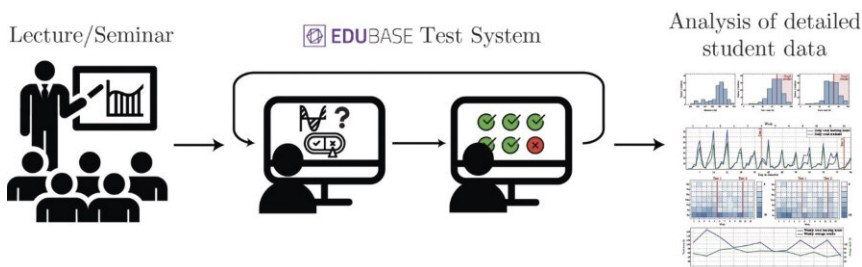

Figure 1: The workflow of teaching methodology using EduBase Test System for online testing, motivation and detailed analysis of student data.

about their knowledge and progress, resulting in a less failure-avoidant attitude towards practising and reduced anxiety about testing. Today's Z- and Alpha-generation students, who have grown up in the digital age, are habituated to using information technology and are motivated by online tools that ensure instantaneous feedback.

The benefits of the testing-effect have been widely discussed via pilot-studies during foreign language learning [3], and it is utilised in popular learning applications like Duolingo and Quizlet. Its effectiveness hasn't yet been investigated in mathematics, however, which

shared (or continuous) learning is essential for deep knowledge on which the further engineering subjects are grounded. However, it is common among students to study in a campaign-like way, so that they can succeed in the course without acquiring profound knowledge. Additionally, freshmen arrive at university with very different mathematical background. Therefore, it is essential to provide other opportunities, in addition to lectures and seminars, to catch up, for self-development and to provide motivation for continuous learning.

To provide these opportunities and to monitor learning performance, we used

After analysing the results at the end of the semester in a class of 115 freshmen, we can conclude that the novel teaching methodology based on continuous retrieval-based learning in EduBase has fulfilled our expectations. The comparison with the control group from previous years, who learnt the conventional way, has shown that drop-out rates have fallen dramatically, and more students are aiming for better grades. In weeks in which new topics were introduced, the time students spent online increased significantly compared to other weeks. In this phase of learning students used testing for learning and training themselves for solving problems rather than checking their acquired knowledge. The end-of-semester results confirmed that scores achieved during

this phase of learning are not necessarily indicative of grades at the end; high marks can be achieved by students who struggle with the homework but practise a lot.

A detailed statistical analysis of EduBase's data showed that students who practised consistently achieved significantly better results at the exam and acquired a deeper level of knowledge than those who crammed for tests. A survey of students confirmed that online testing not only supported their learning but also motivated them to complete maths exercises frequently.

To conclude, we propose a novel test-based methodology that can be applied in real-life university classes with excellent efficiency. EduBase Test

System ensures not only that students practise consistently and can take advantage of catch-up opportunities, but also helps the tutors to continuously monitor learning habits and performance throughout the semester. In further research, this tool could also be applied to analyse relationship between daily routine and performance, and the phenomenon of forgetting and re-learning.

Link:

[L1] <https://www.edubase.net/>

References:

- [1] S. K. Carpenter, H. Pashler, N. J. Cepeda: "Using tests to enhance 8th grade students' retention of U.S. history facts", *Applied Cognitive Psychology*, 23, 760–771, 2019. doi:10.1002/acp.1507

- [2] J. G. W. Raaijmakers, R. M. Shiffrin: "SAM: A theory of probabilistic search of associative memory", in G. Bower (Ed.), *The psychology of learning and motivation* (Vol. 14), New York: Academic Press, 1980.
- [3] A. Keresztes, et al.: "Testing promotes long-term learning via stabilizing activation patterns in a large network of brain areas", *Cerebral Cortex* 24 (11): 3025–3035, Oxford University Press, 2014.

Please contact:

Brigitta Szilágyi, Szabolcs Berezhvai
Budapest University of Technology and Economics, Hungary
szilagyi@math.bme.hu,
berezhvai@mm.bme.hu

When a Master of Sciences on EdTech becomes an International Community

by Margarida Romero, Saint-Clair Lefèvre (UCA, INSPE, LINE) and Thierry Viéville (Inria)

Nelson Mandela said, "Education is the most powerful weapon which you can use to change the world". How do we best achieve this? Part of the answer may lie in SmartEdTech, a Master of Science (MSc) program specialising in digital education.

The MSc SmartEdTech program [L1] at University Côte d'Azur aims to develop a quality approach to digital education with a co-creative and participative education. The program is embedded within a socioeconomic sensibility, specifically related to the Global Goals of the United Nations in relation to education [L2]. The challenge is to both improve today's education and create tomorrow's education, by means of breakthrough digital pedagogies.

As illustrated in Figure 1, the end goal is to allow everyone to develop the "21st century skills", focusing in critical thinking, creativity, problem solving, collaboration and computational thinking as key skills for citizens [1]. We also illustrate how this could apply to computational thinking as a key competency to solve problems through the knowledge of formal systems (how to code) and physical systems (what is a sensor, how a network works, etc.). Through computational thinking development, the students should be able to not only use technology for education

but engage in the critical approach of analysing problem situations, identify technologies to solve these problems.

The MSc SmartEdTech has been designed with an objective of inclusivity to ensure that the students are selected based on their projects and potential [2]. In order to develop an international community, 90% of the program is online, based on open reusable resources in English and some in French. This blended training also includes two intensive weeks, to really meet each other, and to learn and share and intern periods, inside either an EdTech company, or an educational research lab, while some students develop their own spin-off company. Msc SmartEdTech students are expected to become the future e-learning or digital innovation project managers, instructional designers, teacher or e-learning instructors, edTech consultants or researchers in the learning sciences. Students within the MSc SmartEdTech program are professionals from a diverse range of back-

grounds including quality assurance professionals in Higher Education, teachers and university professors, app developers and freelancers in the field of EdTech. They are also engaged in teaching activities within the MSc, embodying the "communities of practices" (CoP) paradigm, in which everyone has the potential to act as a resource for the community.

As students, they will address the challenges of designing and integrating EdTech in their different educational contexts. Our conviction is that they have to learn how to learn, concretely, via effective competence development. The activities developed in the program support active learning approaches through co-creation approaches, Digital game based learning (DGBL), maker education and maker culture. With these different activities, students are engaged to develop a critical understanding of digital sciences and embrace a paradigm of (co)creators of technologies and, therefore, are more than just EdTech consumers. The core

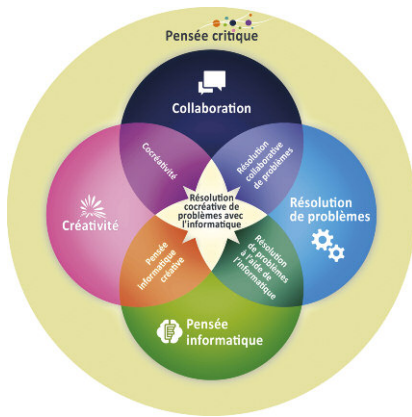

Figure 1: The 21st century educational skills includes, beyond knowledge and know-how, important personal and collective competences, and societal values.

of our paradigm is project-based learning (PBL), meaning that our approach puts everyone's professional project at the heart of learning, right from the start. As such, all courses become an opportunity to realise a given project, while each student has the opportunity to engage in small group teamwork or receive specific coaching.

This MSc benefits from a threefold scientific approach, led by the Learning, INnovation and Education (LINE) research lab [L3], in computer science and education science.

This EdTech MSc not only teaches high-tech tools, but also low-tech approaches. For instance, in order to teach children how a computer works, “unplugged activities”, coupled with creative programming initiation and education robotics, are the pillars of computational thinking learning [3]. In a nutshell, the main point is to use an

everyday situation as a metaphor for a theoretical computer science concept.

Our approach is agnostic with respect to the available tools. This positioning is crucial given the huge social and environmental challenges facing our planet. Whilst the use of digital tools, in education or elsewhere, is neither a panacea, nor the inverse, there are a few things of which we are certain: The core challenge is pedagogy: can digital tools help us improve the pedagogy we want to develop?

The MSc has been running for 18 months and to date our team of nine teachers from six countries have helped about 40 colleagues to contribute to “changing the world through education”. Out of the 12 pioneer students two have created a company or other structure, three are working in research positions, two have been hired by EdTech companies, and the remainder are working on personal projects.

An international community of students

M1 (n=28 2019-2021)
M2 (n=11 2018-2020)



- Asia :
 - India (1)
 - China (1)
 - Japan (1)
 - Philippines (1)
- Africa :
 - Tunisia (1)
 - Ghana (2)
 - Nigeria (4)
 - Burkina Faso (1)
- Europe :
 - France (6)
 - Greece (4)
 - Belgium (1)
 - Spain (1)
 - Germany (1)
 - Georgia (1)
 - Slovenia (1)
 - Hungary (1)
 - Russia (1)
- America :
 - USA (1)
 - Mexico (1)
 - Ecuador (1)
 - Colombia (2)
 - Santa Lucia (1)
- Middle East :
 - Turkey (1)
 - Iran (2)
 - Kazakhstan (1)

Figure 2: The #CreaSmartEdtech Msc international map, featuring 40 students coming from 25 countries gathered to learn together, and start a truly international community.

Perhaps the most interesting and motivating aspect of this experience is the way in which this tiny, lively, global group has started to form a multicultural, interdisciplinary and international community, with a common objective, sharing ideas and practices, being (see Figure 2). This is exactly what this initiative is striving for: to go beyond structured teaching and learning and to build an international community of practice (CoP) in 21st century education.

Links:

- [L1] <https://kwz.me/hK4>
- [L2] <https://kwz.me/hK0>
- [L3] <http://unice.fr/laboratoires/line>

References:

- [1] M. Romero, A. Lepage, B. Lille: “Computational thinking development through creative programming in higher education”, *International Journal of Educational Technology in Higher Education*, 14(1), 42, 2017.
- [2] M. Ciussi, et al.: “Numérique et éducation ... vous avez dit #CreaSmartEdtech ?”, 2018. binaire.lemonde.fr, <https://tinyurl.com/y6n5pwvr>
- [3] D.Menon, et al.: “Going beyond digital literacy to develop computational thinking in K-12 education”, L. Daniela, *Smart Pedagogy of Digital Learning*, Taylor & Francis (Routledge), 9780367333799, 2019. <https://hal.inria.fr/hal-0228103>

Please contact:

Margarida Romero
UCA, INSPE, LINE, France
margarida.romero@univ-cotedazur.fr

EducAzur

The MSc SmartTech is developed in partnership with EducAzur. EducAzur [L1] is a French cluster currently comprising 22 public and private institutions [L2], including Inria, ERCIM and University Côte d'Azur. Its mission is to bring together stakeholders in order to encourage innovative projects between local and national ecosystems and to accelerate experimentation in school, higher education and professional training.



Examples of innovative projects include: the EducAzur and Class'Code partnership to facilitate learning code in the Provence Alpes Côte d'Azur (PACA) region; the organization of conferences on education and artificial intelligence; and its contribution to the Valbonne city's digital educational excellence program. Together with other French clusters and with the support of the Banque des Territoires, EducAzur has contributed to the creation of the Federation of French-speaking EdTech clusters.

[L1] <https://educazur.fr/> [L2] <https://educazur.fr/members/>

DE-TEL - A European initiative for Doctoral Education in Technology-Enhanced Learning

by Mikhail Fominykh and Ekaterina Prasolova-Førland (NTNU)

The Doctoral Education for Technology-Enhanced Learning (DE-TEL) project is developing high quality resources and an internationally recognised program to train PhD students in the area of educational technology. The interdisciplinary expertise that this program will foster is essential for an efficient and effective digitalisation of education in Europe.

Technology-enhanced learning (TEL), also known as educational technology, is a research field that explores new ways of learning enabled by technology and designing new technologies that can support learning in new ways. The term also refers to a learning activity when it is supported by technology in practice. Such practical application of TEL, referred to as the digitisation of education, is being implemented on all levels across Europe. However, digitisation trends are diverse, rapidly changing, and often lack a clear application idea when it comes to putting the theory into practice - thus, educators still employ traditional forms of teaching. Thorough planning is needed to implement these huge technological changes, requiring professionals in TEL with expertise in pedagogy, the design and use of technologies for learning and strategic expertise in policy making and change management at institutional and societal levels.

Schools, universities, private and public organisations, and industry are all expressing a need for interdisciplinary expertise in this area. At a societal level, there is also a growing understanding that in an increasingly complex world learning at all ages must become standard practice.

There is a current lack of TEL experts who combine knowledge from all relevant perspectives, who can strategically drive and operationally implement digitisation of learning, envision innovative technologies for learning, and rigorously create evidence about the effectiveness and efficiency of technologies. Such expertise is generally acquired at the doctoral level of education.

The Doctoral Education for Technology-Enhanced Learning (DE-TEL) project aims to address the challenges of digitisation of education in Europe and the current lack of expertise by improving doctoral education in the area of TEL.

DE-TEL brought together nine internationally renowned universities and the European Association of Technology-Enhanced Learning (EATEL), coordinated by an ERCIM member, the Norwegian University of Science and Technology.

The goal of DE-TEL is to bring doctoral education in TEL to a new level with high-quality resources and a new internationally designed program to support better curricular integration and avoid fragmentation of the digitisation agenda in Europe. The project grounds the design of the new program in the best practices in TEL doctoral education across Europe as well as institutional and national requirements.

DE-TEL will create a new opportunity in an area of research that has practical application across Europe as the digiti-

ciency of technologies as part of socio-technical interventions. Such expertise is required at all levels and at all types of organisations. There is also a growing, recognised understanding by all relevant stakeholders, from EU policy makers to local schools, that technologies have the potential to provide ubiquitous access to learning materials, and an engaging, personalised and scalable learning experience.

Doctoral education in TEL aims to help doctoral candidates to develop such expertise. It provides knowledge from multiple relevant perspectives and allows empirically-based decisions to be made regarding implementing TEL solutions in practice. The goal of DE-TEL is to bring doctoral education in TEL to a new level with high-quality resources and a new internationally designed program to support better cur-

DE-TEL consortium



Figure 1: DE-TEL consortium.

sation of education is increasingly required to solve multiple challenges. Digitisation requires pedagogical expertise in using and technological expertise in designing technologies for learning, and strategic expertise in policy making and change management. However, stakeholders currently lack combined knowledge from all three perspectives, on how to strategically drive and operationally implement digitisation of learning and training, envision innovative technologies for learning, and rigorous methods to create evidence for the effectiveness and effi-

ricular integration and avoid fragmentation of the digitisation agenda in Europe.

The DE-TEL initiative is brought forward by an established community of European researchers and educators gravitating around the activities of the EATEL (The European Conference on Technology-Enhanced Learning - ECTEL and The Joint Summer School on Technology-Enhanced Learning - JTELSS). The consortium will reflect their expertise in doctoral education into a new internationally validated pro-

gram in TEL. The new program will be extended with rich and professionally produced open educational resources.

All resources produced in the project will be open and available free of charge to any interested parties. Moreover, the project is working on an online infrastructure that will allow both the program and the resources to be discussed, updated, translated and

extended by the community during and after the project.

The project will also organise two open face-to-face training events dedicated to piloting the new program and educational resources, preliminary scheduled for 2021 and 2022.

DE-TEL has received funding from the European Union's Erasmus Plus pro-

gram for the period 2019-2022 under grant agreement number 2019-1-NO01-KA203-060280.

Link:
<https://ea-tel.eu/de-tel/>

Please contact:
 Mikhail Fominykh, NTNU, Norway
 (+47) 48603627
mikhail.fominykh@ntnu.no

Ethical Teaching Analytics in a Context-Aware Classroom: A Manifesto

by Romain Laurent (Univ. Grenoble Alpes/LaRAC), Dominique Vaufreydaz (Univ. Grenoble Alpes, CNRS, Inria, Grenoble INP, LIG), and Philippe Dessus (Univ. Grenoble Alpes/LaRAC)

Should Big Teacher be watching you? The Teaching Lab project at Grenoble Alpes University proposes recommendations for designing smart classrooms with ethical considerations taken into account.

The smart education market is flourishing, with a compound annual growth rate regularly announced in double digits (+31% between 2014 and 2018, +18% between 2019 and 2025). Among these EdTech investments, smart classrooms that combine AI and adaptive learning are in the spotlight. Although

smart classrooms encompass a large range of different products, we can define them as physical environments in which teaching-learning activities are carried out using computerised devices and various techniques and tools: signal processing, robotics, artificial intelli-

gence, sensors (e.g., cameras, microphones) and effectors (e.g., loudspeakers, displays, robots).

Despite all the hype around smart classrooms, it seems that the ethical and privacy aspects of these developments are seldom considered. This issue is not

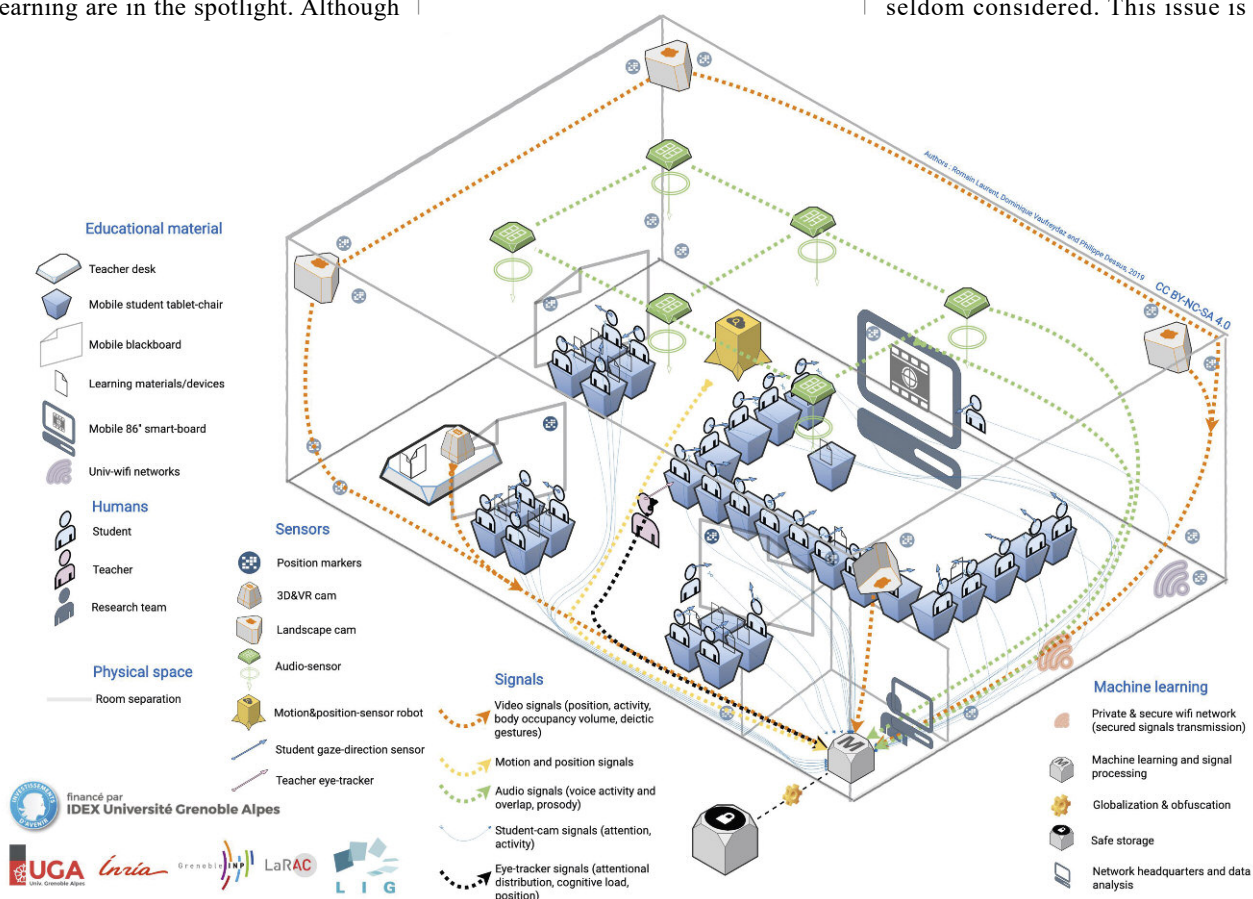

Figure 1: Setting of the Context-Aware Classroom designed by the Teaching Lab Project at University Grenoble Alpes.

incidental: it conditions not only the classroom atmosphere and the ethics of the institution, but also the quality of interpersonal relationships within the classroom and teaching–learning processes — which universities often claim to support.

This leads to a series of questions. Which signals will be captured and stored? How will the consent of the individuals be gathered? Should the machine monitor everything that happens in the classroom? Will unduly collected signals be excluded (e.g., a camera-captured personal message, a microphone-captured conversation, an inappropriate behaviour)? If yes, how? Ex ante (by the machine) or ex post (by the operators)? Will the machine remain spectator or will it act in real time using effectors? How will the system thenceforth react to learners' and even teachers' behaviours that might be considered dilatory? What outcomes are we likely to see from the highly delicate interpretation of features inferred from data? In response and to counter any surveillance, what opacifying behaviours or layers will be implemented by the interactors? What trust can then be established between the teacher enhanced (and possibly monitored) by technology, the student under scrutiny and the institution receiving this dataveillance [1]?

Teaching and learning are fragile activities that rely above all on the commitment of participants. This mutual commitment is rooted in trust and respect, which can only flourish and prosper on the integrity of the relationship between the teachers, the students and the institution that oversees it. This integrity paves at last the way for relatedness, known as critical in student's achievement [2]. The introduction of smart technologies to the classroom, if not framed by explicit ethical and privacy-compliant principles and purposes, could easily be used for dataveillance of its participants, jeopardizing classroom interactions and corrupting the effectiveness of teaching/learning processes [1].

We designed a smart classroom (Teaching Lab project at Grenoble Alpes University, funded by the "PIA 2 IDEX formation program"), with essential ethical safeguards in mind that respect individuals' privacy as a prerequisite for the physical, technological

and theoretical development of these spaces. The class smartness is exploited in two directions. On the one hand, it authorises the basic collection of educational data (in particular the distribution of attention between teacher, students and learning materials), and their processing by machine learning techniques. On the other hand, it subordinates them to an ethical framework that respects the protagonists, following the safeguards for privacy and data protection in ambient intelligence [3]. To do so, we will use advanced machine learning techniques to shed light on global features while obfuscating local ones. Our objective is twofold. First, we owe privacy to each participant to the extent that everyone's privacy is interwoven with that of everyone else. Secondly, we aim to not bias the genuineness of observed behaviours. We assume there that each individual's protection is a good way to strengthen the global gathered information (e.g. interactions, relatedness).

For this purpose, we propose four key guidelines as the core of the Teaching Lab design:

1. We develop an ethics-by-design approach: beyond their common contribution in terms of signal processing, machine learning techniques will be used to anonymise, at their source, attendees' data and filter any item likely to alter the confidence of the protagonists in the instructional flow. Thus, the Teaching Lab obfuscates all participants, while focusing on meaningful events and constructs (gaze, teacher cognitive load, hand, deictic, gesture, non-personal devices, voice activity and overlap, prosody).
2. We promote a global rather than local methodology: students' behaviours will never be individually traceable; the machine learning being limited to restore a globalised picture of the occurrence of behaviours. In other words, our data reports about the whole classroom but ignores individuals.
3. Finally, machine learning will be intentionally constrained to a delayed feedback, filtered by the research team, excluding any real-time monitoring or ad hominem reports. Our aim is only to support interactors' possible professional development (students included), by studying and providing feedback

about the factors reinforcing or weakening attention in class.

4. The Teaching Lab will not make high-stakes decisions, monitor staff performance or student insulation. Following the University of Edinburgh's Learning Analytics' principles and purposes, we contend that data and algorithms can contain and perpetuate biases, and that they never provide the whole picture about human capacity or likelihood of success.

These guidelines are intended to ensure the privacy, security and trust of every individual within the smart classroom, thereby preserving relationships, interactions, and the research for improving teaching and learning processes.

Links:

- [L1] University of Edinburgh Principles and purposes for Learning Analytics: <https://kwz.me/hK7>
 [L2] Teaching Lab Project website: <https://project.inria.fr/teachinglab/>

References:

- [1] R. Crooks: "Cat-and-Mouse games: Dataveillance and performativity in urban schools", *Surveillance and Society*, vol. 17, no. 3/4, pp. 484–498, 2019.
- [2] G. Hagenauer, S. E. Volet: "Teacher-student relationship at university: an important yet under-researched field", *Oxford Review of Education*, vol. 40, no. 3, pp. 370–388, 2014.
- [3] P. De Hert, S. Gutwirth, A. Moscibroda, D. Wright, and G. González Fuster, "Legal safeguards for privacy and data protection in ambient intelligence," *Personal and Ubiquitous Computing*, vol. 13, no. 6, pp. 435–444, 2008.

Please contact:

Romain Laurent
 Univ. Grenoble Alpes/LaRAC, France
romain.laurent@univ-grenoble-alpes.fr

Dominique Vaufreydaz
 Univ. Grenoble Alpes, CNRS, Inria, Grenoble INP, LIG
dominique.vaufreydaz@inria.fr

Philippe Dessus
 Univ. Grenoble Alpes/LaRAC, France
Philippe.Dessus@univ-grenoble-alpes.fr

KANDINSKY Patterns: A Swiss-Knife for the Study of Explainable AI

by Andreas Holzinger (Medical University Graz and Alberta Machine Intelligence Institute Edmonton, Canada), Peter Kieseberg (University of Applied Sciences, St.Poelten) and Heimo Müller (Medical University Graz)

Kandinsky Patterns are mathematically describable, simple, self-contained, hence controllable test datasets for the development, validation and training of explainability in artificial intelligence (AI) and machine learning (ML).

In machine learning we design, we develop, we test, and we evaluate algorithms, which can learn from data and extract knowledge and make predictions. This is very helpful for decision support systems and decision making, particularly in the medical domain. One family of machine learning algorithms is deep learning, which is now extremely successful. Deep learning reaches human-level performance in classification tasks even in the medical domain, with a classification performance of 92% and better. However, the big problem here is its “black-box” nature, i.e., a medical expert is currently unable to retrace, replicate and understand the underlying explanatory factors of why the 92% have been achieved, for instance. Particularly in medicine, the question of why is often more important than the classification result itself [1], therefore the field of “explainable AI” is becoming more and more important [2].

Human experts can explain certain results very well, because humans are able to use abstract concepts. Causality and concept learning are important to understand how humans extract so much information, often from just a few data points, and to contrast this with machine learning which is now addressing “explainable AI”. For the study of explainable AI, we have designed and developed an experimental explanation environment for testing explainability concepts of both human intelligence and artificial intelligence. We made this environment fully accessible for the international machine learning community and called it Kandinsky Patterns, in memory of the great painter Wassily Kandinsky. But there is another story behind these patterns: In the past we have observed how pathologists work [1]. Pathology is a very interesting medical specialty; pathologists explain and interpret geometric objects and geometric structures (Figure 1). They even speak of geometrical architectures, and they observe and interpret shapes, objects, colour, similarity, Gestalt phenomena, etc., and finally come up with an explanation in written form - the diagnosis. For a number of reasons, this process is very difficult for machine learning algorithms.

The Kandinsky Patterns enable the study of such phenomena and to test, benchmark and evaluate machine learning algorithms under mathematically strictly controllable conditions [L1], [L2], but which at the same time are accessible and

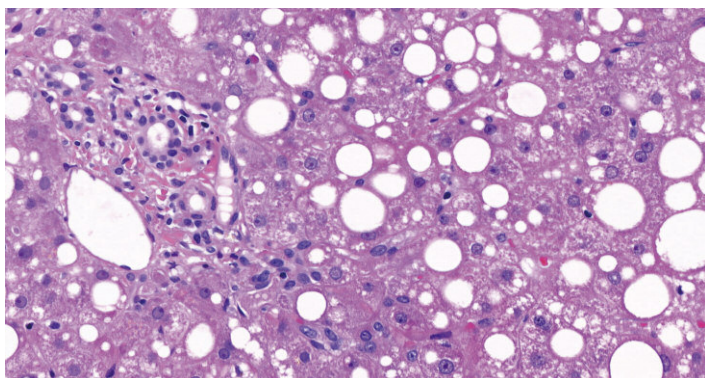

Figure 1: A typical interpretation task in pathology: The (human) pathologist interprets and explains geometrical architectures, shapes, objects, colour, similarity, etc., and produces an explanation – the medical report [1].

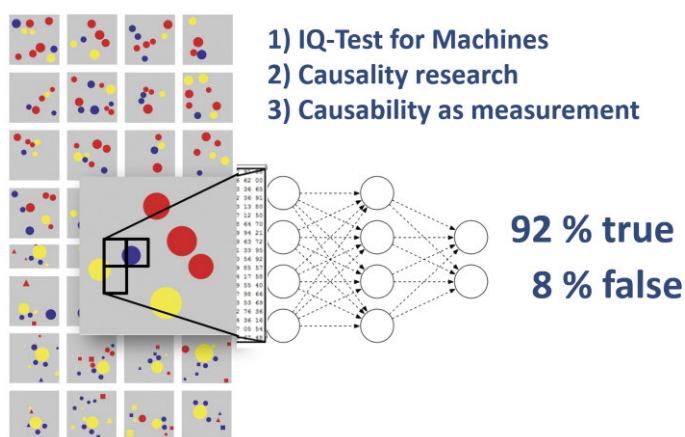

Figure 2: Kandinsky Patterns as an experimental environment for explainable AI – to answer the question of why the classificatory came up with 92% [L2].

understandable for human observers. It is also possible to produce a ground truth. That means, we can produce images that the tested classifier should evaluate as true, thereby allowing various ways of testing machine learning algorithms. Thus, Kandinsky Patterns can be used as a kind of intelligence test for algorithms [3]. Kandinsky Patterns allow validation of results of arbitrary machine learning algorithms, but most of all, explainable AI methods can be tested, evaluated and further developed based on these experiments. This even allows for the development of completely new explanation methods. Moreover, with our Kandinsky Generator we can produce “false patterns” that can be used to test the robustness of algorithms in a controlled setting. This will be extremely important in the future, as adversarial examples have already demonstrated their potential in attacking security mechanisms applied in various domains, especially medical environments. Last, but not least, Kandinsky Patterns can be used to produce “counterfactuals” – the “what if”, which is difficult to handle for both humans and machines - but can provide new insights into the behaviour of explanation methods.

In conclusion, Kandinsky Patterns (Figure 2) can be used as “IQ-Test for machines”, for causality research and to evaluate explainable AI methods, i.e. to use causality as measurement [1].

Links:

- [L1] <https://human-centered.ai/project/kandinsky-patterns/>
- [L2] <https://www.youtube.com/watch?v=UuiV0icAIRs>

References:

- [1] A. Holzinger, et al.: 2019. Causability and Explainability of Artificial Intelligence in Medicine. Wiley Interdisciplinary Reviews: Data Mining and Knowledge Discovery, 9, (4), 2019, doi:10.1002/widm.1312
- [2] R. Goebel, et al.: “Explainable AI: the new 42?”, in International Cross-Domain Conference for Machine Learning and Knowledge Extraction (pp. 295-303), 2018. doi: doi:10.1007/978-3-319-99740-7_21
- [3] A. Holzinger, M. Kickmeier-Rust, H. Müller: “KANDINSKY Patterns as IQ-Test for Machine Learning”, in International Cross-Domain Conference for Machine Learning and Knowledge Extraction (pp. 1-14). Doi:10.1007/978-3-030-29726-8_1

Please contact:

Andreas Holzinger
 exAI Lab, Alberta Machine Intelligence Institute,
 Edmonton, Canada and Medical University Graz, Austria
andreas.holzinger@medunigraz.at

Building Reliable Storage Systems

by Ilias Iliadis (IBM Research – Zurich Laboratory)

A huge and rapidly growing amount of information needs to be stored on storage devices and on the cloud. Cloud users expect fast, error-free service. Cloud suppliers want to achieve this high quality of service efficiently to minimise cost. Redundancy, in particular erasure coding, is widely used to enhance the reliability of storage systems and protect data from device and media failures. An efficient system design is key for optimising operation.

Today’s storage systems must store an enormous amount of data across multiple storage units. Regardless of the quality of the storage technology, errors will occur. It is therefore possible that one of these storage unit could fail in its entirety. To further protect data from being lost and to improve the reliability of the data storage system, replication-based storage systems spread replicas corresponding to data stored on each storage device across several other storage devices. This is done in a way that allows the data to be recovered even if a whole storage unit fails. To improve the efficiency of the replication schemes, “erasure coding” schemes that provide a high data reliability as well as high storage efficiency are deployed.

User data is divided into blocks (or symbols) of a fixed size (e.g., sector size of 512 bytes) and complemented with parity symbols to form codewords. From these codewords, the original data can be restored. Also, these codewords can be placed on the available devices in different ways, which affects the reliability level achieved. The two basic placement schemes, clustered and declustered, are shown in Figure 1. The clustered placement scheme stores data and its associated parities in a set of devices with the number of devices being equal to the codeword length whereas the declustered placement spreads data and its associated parities across a larger number of devices.

When storage devices fail, codewords lose some of their symbols, and this leads to a reduction in data redundancy. The system attempts to maintain its redundancy by reconstructing the lost codeword symbols using the surviving

symbols of the affected codewords. When a clustered placement scheme is used, the lost symbols are reconstructed directly in a spare device, as shown in Figure 2.

When a declustered placement scheme is used, as shown in Figure 3, spare space is reserved on each device to temporarily store the reconstructed codeword symbols before they are transferred to a new replacement device. The rebuild bandwidth available on all surviving devices is used to rebuild the lost symbols in parallel, which results in smaller vulnerability windows compared to the clustered placement scheme.

The redundancy in the block-coding scheme and in the replication over several storage units, adds to the cost of the system. Another cost is the transmission capacity required between the storage units for block recovery. An additional performance cost is incurred by the update operations associated with the redundancy scheme.

Reliability is assessed via the Mean Time to Data Loss (MTTDL) and the Expected Annual Fraction of Data Loss (EAFDL) metrics. For such a storage system to operate efficiently with good quality of service, one is faced with a multi-dimensional optimisation problem. We have tackled this problem theoretically by developing a method to derive the MTTDL and EAFDL metrics analytically for various data placement schemes.

The methodology uses the direct path approximation and does not involve Markovian analysis [1]. It considers the most likely paths that lead to data loss, which are the shortest ones. It turns out that this approach agrees with the principle encountered in the probability context expressed by the phrase “rare events occur in the most likely way”. The reliability level of systems composed of highly reliable components is essentially determined by the “main event”, which is the shortest way to failure [2].

The analytical reliability expressions derived can be used to identify redundancy and recovery schemes as well as data placement configurations that can achieve high reliability. Superior reliability is achieved by a distributed data placement scheme, which spreads redundant data associated with the data stored on a given device in a declustered fashion across several devices in the system.

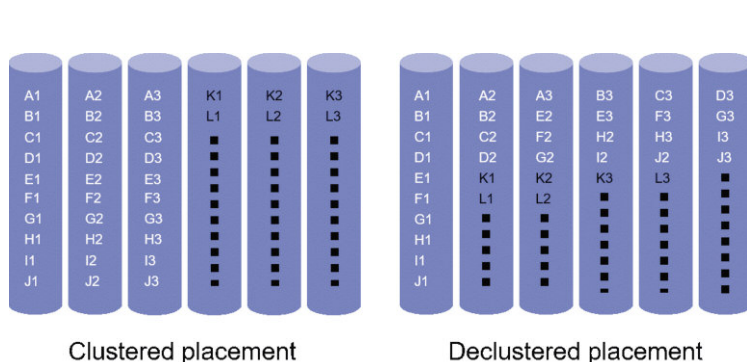

Figure 1: Clustered and declustered placement of codewords of length three on six devices. $X1, X2, X3$ represents a codeword ($X = A, B, C, \dots, L$).

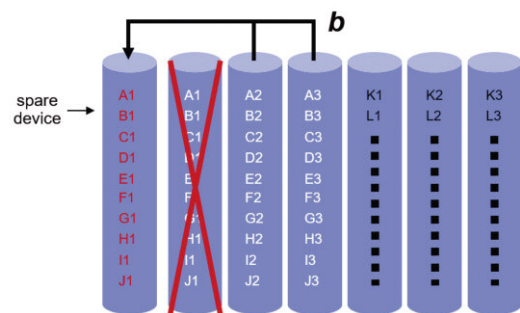

Figure 2: Rebuild under clustered placement.

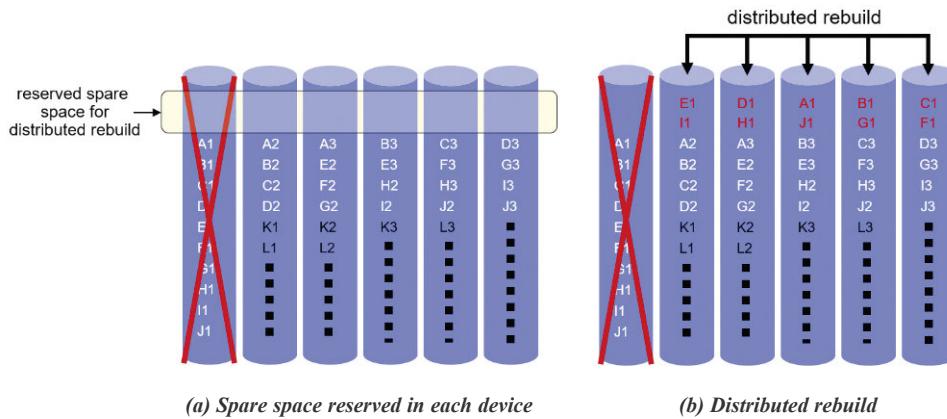

Figure 3: Rebuild under declustered placement.

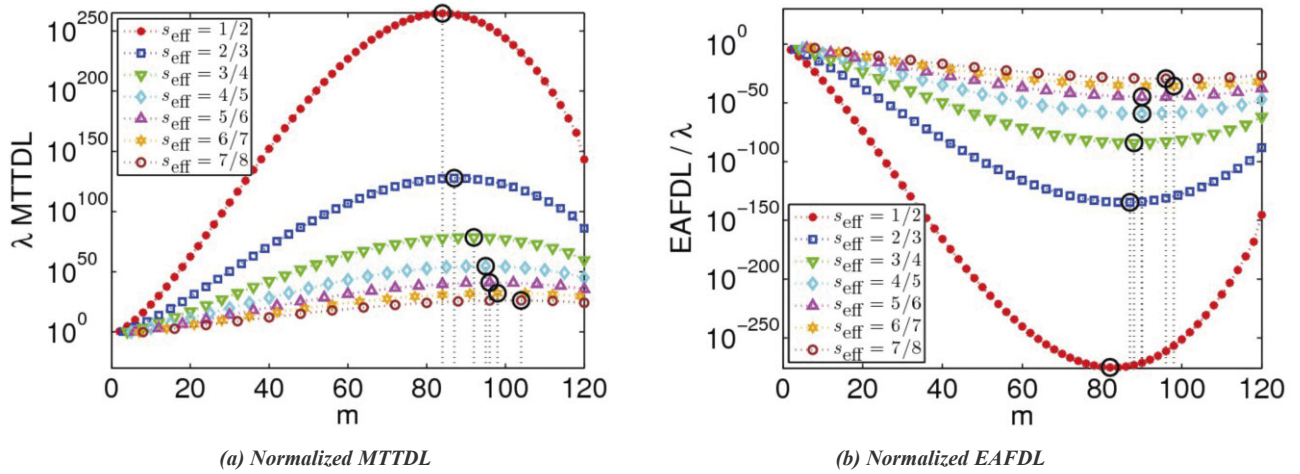

Figure 4: Reliability versus codeword length for various storage efficiency values.

Contrary to general assumption, we found that increasing codeword length does not necessarily improve reliability. This is demonstrated in Figure 4, which plots reliability as a function of codeword length (m) for various storage efficiency values. It demonstrates that increasing codeword length initially improves reliability, but at some point reliability begins to degrade. This is due to two opposing effects: on the one hand, larger codeword lengths imply that codewords can tolerate more device failures, but on the other hand, they result in a higher exposure degree to failure as each of the codewords is spread across a larger number of devices. Further insights into this subtle phenomenon are offered by additional results, presented graphically in [1].

The effect of successive device failures that are correlated has also been considered [3]. The existing theoretical models can be enhanced to also consider the correlation effect according to the methodology detailed in [3]. The results obtained demonstrate that correlated device failures have a negative impact on reliability.

Links:

General information about cloud storage systems: <https://www.zurich.ibm.com/cloudstorage/>

References:

- [1] I. Iliadis: “Reliability Evaluation of Erasure Coded Systems under Rebuild Bandwidth Constraints”, International Journal on Advances in Networks and Services, vol. 11, no. 3&4, pp. 113-142, December 2018.
- [2] I. Iliadis and V. Venkatesan: “Most Probable Paths to Data Loss: An Efficient Method for Reliability Evaluation of Data Storage Systems”, International Journal on Advances in Systems and Measurements, issn 1942-261x, vol. 8, no. 3&4, pp. 178-200, December 2015.
- [3] I. Iliadis, et al.: “Disk Scrubbing Versus Intradisk Redundancy for RAID Storage Systems”, ACM Trans. Storage, vol. 7, no. 2, article 5, 42 pages, July 2011.

Please contact:

Ilias Iliadis
 IBM Research – Zurich Laboratory
 ili@zurich.ibm.com

Browse, Visualise, Analyse EU Procurement Data

by Ahmet Soylu and Till C. Lech (SINTEF)

Annually, around 14% of the EU's GDP is spent on the procurement of goods and services by over 250,000 public authorities. Improving the effectiveness, efficiency, transparency and accountability of government procurement is therefore in the public's interest. The increasing amount of open procurement data enables us to analyse public spending to deliver better quality and more economical public services, prevent fraud and corruption, and build healthy and sustainable economies.

TheyBuyForYou [L1] is a three year project, funded by European Union's Horizon 2020 program, that aims to build a technology platform consisting of a set of modular web-based services and APIs, to publish, curate, integrate, analyse, and visualise an open, comprehensive, cross-border and cross-lingual procurement knowledge graph, including public spending and corporate data from multiple sources across the EU.

Many of the tools in use by governments are not optimised for government use or are subject to restrictive contracts that create unnecessary complications when it comes to publishing open data. Other contracts, such as contracts for tender advertising portals, are hampering the progress of transparency because the portals are claiming copyright over all data published in the portals, even though their public-sector clients are the authors and the data on tender opportunities are required to be published openly by law. The technical landscape for managing such contracts is very heterogeneous: for example, even in medium-sized cities, contracts are handled using different tools and formats across departments, including relational databases, Excel spreadsheets, and Lotus Notes. This makes it difficult to achieve a high-level overview of processes and decisions. There are various initiatives, such as Open Contracting Data Standard (OCDS), that aim to create de-jure and de-facto standards for elec-

tronic procurement. However, these are mostly oriented to achieve interoperability (i.e., addressing communication between systems), document oriented (i.e., the structure of the information is commonly provided by the content of the documents that are exchanged), and provide no standardised practices to refer to third parties, companies participating in the process, or even the main object of contracts. In short, there is enormous heterogeneity in systems and processes. The Semantic Web approach has the potential to benefit the procurement domain by allowing the reuse of existing vocabularies, ontologies, and standards.

The TheyBuyForYou project explores how procurement knowledge graphs, paired with data management, analytics and interaction design could be used to reform four key procurement areas [1]: (i) economic development: facilitating better economic outcomes from public spending for SMEs; (ii) demand management: spotting trends in public spending to achieve long-term goals such as savings; (iii) competitive markets: promoting healthier competition and identifying collusions and other irregularities; and (iv) supplier intelligence: optimising supply chains. The project develops an integrated technology platform with data, core services, open APIs and online tools, which will be validated in different business cases.

The project is underway and we have integrated two high-quality datasets according to an ontology network [2], company (i.e., legal entities) and procurement (e.g., tenders and contracts) data, to form an interconnected knowledge graph for public procurement. We ingest data from two main providers: OpenCorporates [L2] for supplier data (i.e., company) and OpenOpps [L3] for procurement data. OpenOpps has gathered over 2,000,000 tender documents from more than 300 publishers through web scrapping and by using open APIs, while OpenCorporates currently has 1,400,000 entities collected from national registers. The data ingestion process comprises several steps using data APIs of both providers, including data curation (e.g., handling missing values and duplicates), matching suppliers appearing in tender data against company data (i.e., reconciliation), and translating datasets into the underlying graph data representation (i.e., RDF) with respect to the ontology network [3]. The current release of the knowledge graph includes 2,300,000 triples (i.e., records) [L4]. An example query and its results are depicted in Figure 1. The example query lists the top ten companies that constitute the major suppliers, in the Norwegian jurisdiction, where the jurisdiction data comes from OpenCorporates and contract data comes from OpenOpps. In addition to the knowledge graph and data ingestion components, we are developing a set of online toolkits including cross-language document comparison and analytics components; anomaly detection components; a comprehensive set of guidelines for data visualisation and interaction design; and a design for a story-telling tool.

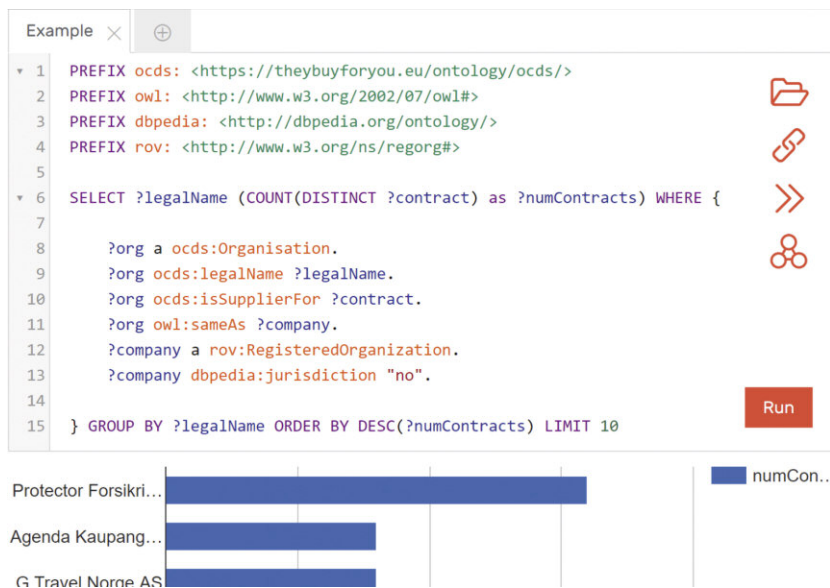

Figure 1: An example query executed on the TBFY knowledge graph integrating two datasets.

issues, which turns out to be considerable challenge. Currently, we are working on various approaches to improve data quality, ranging from machine learning to crowd-sourcing. Finally, we are consolidating an integrated platform with data access APIs and online tools supporting different data analytics tasks. A series of business cases are being built on top of the knowledge graph and online tools to realise the aforementioned four key innovation areas.

The project consortium is composed of SINTEF (coordinator, Norway), University of Southampton (UK), OpenOpps (UK), OpenCorporates (UK), Cerved (Italy), Ministrstvo za Javno Upravo (Slovenia), Ayuntamiento de Zaragoza (Spain), Jozef Stefan Institute (Slovenia), Oesía Networks SL (Spain), and Universidad Politecnica de Madrid (Spain).

Links:

[L1] <https://theybuyforyou.eu/>

[L2] <https://opencorporates.com/>

[L3] <https://openopps.com/>

[L4] <http://data.tbfy.eu>

References:

- [1] Simperl et al.: “Towards a Knowledge Graph Based Platform for Public Procurement”, in Proc. of MTSR 2018.
- [2] Soyly et al.: “Towards an Ontology for Public Procurement Based on the Open Contracting Data Standard”, in Proc. of I3E 2019.
- [3] Soyly et al.: “An Overview of the TBFY Knowledge Graph for Public Procurement”, in Proc. of ISWC Satellites 2019.

Please contact:

Ahmet Soyly, SINTEF, Norway
ahmet.soyly@sintef.no

More on 5G: Millimetre-Waves

by Gregor Dürrenberger (FSM) and Harry Rudin

The tumult surrounding 5G continues in Switzerland. The telecommunications providers are intensely promoting 5G; industry is waiting for 5G, citizens are concerned about potential health issues associated with 5G, and the press is full of articles about 5G. In a few years, the technology will also use millimetre-wave transmission. In anticipation of this in June this year the Swiss Research Foundation for Electricity and Mobile Communication (FSM) at the Swiss Federal Institute of Technology in Zurich organised a millimetre-wave workshop.

The millimetre-wave workshop, held in Zurich in June, 2019, touched on many topics, most of which were directly or indirectly related to the interaction between millimetre-waves and humans, and the ways that 5G might impact us. Many of the charts from the presentations are available at [L1].

Millimetre-waves have been around us for a long time: They have many commercial applications such as material surface treatment and physical measurements and are also used in radar for contactless detection systems, such as speed detectors and weather radar. Other applications are directly relating to people, including medical applications, such as computer tomography scans. An overview of commercially available applications was given by Christoph Baer, Ruhr-University in Bochum, and of biomedical applications by Maxim Zhadobov, French National Centre for Scientific Research, Rennes.

The public’s main concern is the effect of 5G millimetre-waves on our health and wellbeing. We know that electromagnetic fields interact with the human body. The type of interaction depends on frequency, the magnitude of effects on field-strength or power. In the microwave and millimetre-wave domains exploited by mobile communication technologies, the relevant interaction mechanism is believed to be energy absorption.

It is known, as Maria Rosaria Scarfi from the Bio-EM Lab in Naples pointed out, that overexposure may have detrimental health effects on the tissue level like coagulations, structural protein damage or disruption of organic functions. However, regulatory frameworks limit human exposure and protect against such risks. In terms of non-thermal biological effects that might occur at low exposure levels, no experimentally verified mechanism is known for either microwaves or millimetre-waves.

Scarfi presented a literature analysis of published in-vitro experiments with millimetre-waves. Most articles reported effects, many of them beneficial in nature. However, given the low quality of most studies, especially regarding dosimetry, it is premature to draw conclusions. This makes it almost impossible to separate thermal from potential non-thermal effects. Furthermore, no consistent correlation between effects and exposure conditions (frequency, power density, exposure duration) could be identified. This might reflect the real situation, however, it is possibly an artefact stemming from experimental choices or publication bias. Scarfi concludes “The available studies do not provide sufficient and adequate information for meaningful safety assessments” and she sees an urgent need for further, more carefully controlled studies.



Figure 1: Attentive Audience at ETH during FSM Millimeter-Wave Workshop. Photo: FSM.

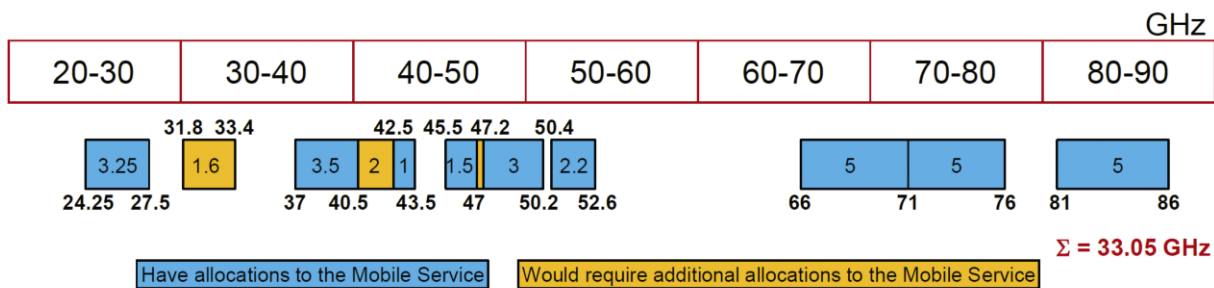

Figure 2: Sub-THz frequency allocation plan for mobile services. Source: workshop-presentation of Philippe Horisberger, BAKOM.

The complexity and challenges of bio-research, including modelling, with millimetre-waves was further elaborated by Joachim Oberhammer from Karolinska Institute, Stockholm, Daniel Erni, University of Duisburg-Essen (presentation given by Sonja Huclova) and Sven Kühn from IT'IS, Zurich. The talks focused on the skin, which is the relevant interaction tissue for wavelengths in the millimetre range. Huclova showed that we need multi-scale skin models in order to properly assess energy absorption of microscopic structures such as hair channels and sweat ducts, and more empirical research into the tissue parameters for sub-THz frequencies. This call for more accurate numerical models and measurement data was corroborated by Kühn's presentation, which stressed limitations in the current exposure guidelines that require review and updating.

Oberhammer's presentation introduced millimetre-waves as diagnostic tools, especially for skin-cancer screening. Currently, no technology is available to perform screenings that are efficient in terms of both time and money. The sensor-concept presented is a solution that has already been tested. Its rationale: because melanoma have higher water content compared to healthy tissue or benign tumours, scanning absorption rates of electromagnetic millimetre-wave energy with probes allows identification of malignant tumours very quickly, even by non-dermatologists. Oberhammer described the first micromachined, high-resolution probe with a size below 1 mm and an operating frequency of 100 GHz.

In an earlier paper, "5G: A View from Switzerland" [L2] the authors wrote about the public's concerns regarding 5G frequency allocation and non-ionizing radiation limits as they pertain to mobile wireless communication. Three presentations at the workshop were devoted to this topic. Philippe Horisberger from the Swiss Federal Office of Communications (BAKOM) reported on the many institutions working on the standardisation of 5G, including frequency band allocation on the global level. The organisations working on these tasks include, among many others, the IEEE and ITU at the international level, ETCI and CEPT in Europe, and many industry and national standardisation organisations. The roadmap for harmonisation of the 26 GHz band in Europe was presented as well as the planned allocation of a total of a bandwidth of 33 GHz in the domain between 24 and 86 GHz scheduled for the World Radio Conference in November 2019.

Specifically related to health issues is the ICNIRP, the International Commission on Non-Ionizing Radiation Protection. Martin Rössli, member of the commission, dis-

cussed the current (preliminary) status of the revision of ICNIRP's guidelines in the millimetre-microwave region. The guidelines are specifically aimed at protecting humans from potentially detrimental health risks under realistic circumstances for two specific populations: the general public and those people particularly exposed through their professional work. The presentation focused on both microwave and millimetre-wave frequencies. Concerning the latter, ICNIRP intends to make the following major adjustments (proposal status): first, maximum energy absorption by the body (technically defined as Specific Absorption Rate SAR) must be respected up to 300 GHz (formerly: 10 GHz). Second, the regulation on maximum power density starts with 6 GHz (formerly 10 GHz). Finally, SAR should extend down to 6 GHz (formerly 10 GHz), so, between 6 and 10 GHz both SAR and power density limits must be respected.

We look forward to the imminent revision of the ICNIRP guidelines.

IEEE recommends similar, but not identical, standards as ICNIRP. Work is underway to consolidate the recommendations of those two bodies. Ralf Bodemann, EMF consultant from Munich and former Chairman of IEEE ICES aka IEEE Standards Coordinating Committee 39 (SCC 39), explained the current status of the revision process: only marginal revisions to the current guidelines are under discussion, and they include the addition of exposure standards for consumer goods.

Workshop participants received a research update on millimetre-waves, from technical to biological issues, to the status of ongoing discussions on regulatory revisions. An important outcome of the 1.5 day gathering at ETH in Zurich was that the scientific community needs additional tissue data and more detailed models to properly simulate the interaction between millimetre-waves and the skin, and it needs more high-quality in-vitro bio-experiments in order to verify or to falsify the as yet unclear status of the many effects reported in literature.

Links:

[L1] <https://kwz.me/hK5>

[L2] <https://ercim-news.ercim.eu/en117/special/5g-a-view-from-switzerland>

Please contact:

Gregor Dürrenberger, Swiss Research Foundation for Electricity and Mobile Communication, ETH Zurich, +41 44 632 5978 gregor@emf.ethz.ch

QONFEST

 Vienna, Austria
 August 31 – September 5, 2020

ANNOUNCEMENT and CALL for PAPERS

FMICS 2020: 25th International Conference on Formal Methods for Industrial Critical Systems

Austria, 2-3 September 2020

FMICS is the yearly conference organised by the homonymous ERCIM working group. The aim of the conference series is to provide a forum for researchers who are interested in the development and application of formal methods in industry. FMICS brings together scientists and engineers active in the area of formal methods and interested in exchanging their experiences in the industrial usage of these methods. The conference series also strives to promote research and development for the improvement of formal methods and tools for industrial applications. This 25th edition will be celebrated in a special way.

QONFEST 2020

FMICS 2020 is part of the QONFEST umbrella conference comprising also CONCUR, FORMATS, and QEST, along with workshops and tutorials, from August 31 to September 5, 2020. The topics covered by QONFEST are theory, formal modelling, verification, performance evaluation and engineering of concurrent, timed, industrial critical, and other systems. FMICS 2020 features a special track on "Formal Methods for Security in IoT".

Submission and Publication

The paper submission deadline is May 15, 2020. Accepted papers will be included in the Conference Proceedings published in Springer's Lecture Notes in Computer Science in the subline on Formal Methods. Authors of selected papers will be invited to submit an extended version of their paper to a special issue of the "International Journal on Software Tools for Technology Transfer".

Conference Chairs:

Maurice ter Beek, ISTI-CNR (PC co-chair), Dejan Ničković, AIT (PC co-chair), Ezio Bartocci, TU Wien (General chair).

Invited Speakers

- Thomas Henzinger, IST (joint keynote with CONCUR and QEST)
- Stefan Resch, Thales
- Roderick Bloem, TU Graz (joint keynote with CONCUR and FORMATS)

More information:



ERCIM Membership

ERCIM membership is open to research institutions (including universities). By joining ERCIM, your research institution or university can participate in ERCIM's activities and contribute to the ERCIM members' common objectives playing a leading role in Information and Communication Technology in Europe.

"Through a long history of successful research collaborations in projects and working groups and a highly-selective mobility programme, ERCIM has managed to become the premier network of ICT research institutions in Europe. ERCIM has a consistent presence in EU funded research programmes conducting and promoting high-end research with European and global impact. It has a strong position in advising at the research policy level and contributes significantly to the shaping of EC framework programmes. ERCIM provides a unique pool of research resources within Europe fostering both the career development of young researchers and the synergies among established groups. Membership is a privilege."

Dimitris Plexousakis,
 Director of ICS-FORTH, Greece

About ERCIM

ERCIM – the European Research Consortium for Informatics and Mathematics – aims to foster collaborative work within the European research community and to increase cooperation with European industry. Founded in 1989, ERCIM currently includes 17 leading research establishments. ERCIM is able to undertake consultancy, development and educational projects on any subject related to its field of activity.

ERCIM members are centres of excellence across Europe. ERCIM is internationally recognized as a major representative organization in its field. ERCIM provides access to all major Information Communication Technology research groups in Europe and has established an extensive program in the fields of science, strategy, human capital and outreach. ERCIM publishes ERCIM News, a quarterly high quality magazine and delivers annually the Cor Baayen Award to outstanding young researchers in computer science or applied mathematics. ERCIM also hosts the European branch of the World Wide Web Consortium (W3C).

contact@ercim.eu



ERCIM “Alain Bensoussan” Fellowship Programme

The ERCIM PhD Fellowship Programme has been established as one of the premier activities of ERCIM. The programme is open to young researchers from all over the world. It focuses on a broad range of fields in Computer Science and Applied Mathematics.

The fellowship scheme also helps young scientists to improve their knowledge of European research structures and networks and to gain more insight into the working conditions of leading European research institutions.

The fellowships are of 12 months duration (with a possible extension), spent in one of the ERCIM member institutes. Fellows can apply for second year in a different institute.

Why to apply for an ERCIM Fellowship?

The Fellowship Programme enables bright young scientists from all over the world to work on a challenging problem as fellows of leading European research centers. In addition, an ERCIM fellowship helps widen and intensify the network of personal relations and understanding among scientists. The programme offers the opportunity to ERCIM fellows:

- to work with internationally recognized experts;
- to improve their knowledge about European research structures and networks;
- to become familiarized with working conditions in leading European research centres;
- to promote cross-fertilization and cooperation, through the fellowships, between research groups working in similar areas in different laboratories.

Conditions

Candidates must:

- have obtained a PhD degree during the last eight years (prior to the year of the application deadline) or be in the last year of the thesis work with an outstanding academic record;
- be fluent in English;
- have completed their PhD before starting the grant;
- submit the following required documents: cv, list of publications, two scientific papers in English, contact details of two referees.

“ Having a ERCIM Postdoc was a great opportunity! I moved to another country, I met new people and I worked in machine learning applied to industry. This definitely changed my career. Thanks a lot!



Rita Duarte PIMENTEL
Former ERCIM Fellow



“ ERCIM fellowship certainly contribute to enhance current and future career prospects and opportunities. In addition, ERCIM fellowship gives chances for increasing the network of contacts and setting up international collaborations, mainly through short visiting periods in other ERCIM institutes and conferences. I strongly recommend this Fellowship, which is also a great life experience.



Ahmed ELARABY
Former ERCIM Fellow



“ It was a holistic experience, and the realization of the experience and knowledge I gained only grows each time I look back on it. ERCIM fellowship is a unique opportunity that needs to be grasped, that shapes your future and can give you experiences that will inspire you for many years.



Naveed Anwar BHATTI
Former ERCIM Fellow



The fellows are appointed either by a stipend (an agreement for a research training programme) or a working contract. The type of contract and the monthly allowance/salary depends on the hosting institute.

Application deadlines

Deadlines for applications are currently 30 April and 30 September each year.

Since its inception in 1991, over 500 fellows have passed through the programme. In 2019, 53 young scientists commenced an ERCIM PhD fellowship and 79 fellows have been hosted during the year. Since 2005, the Fellowship Programme is named in honour of Alain Bensoussan, former president of Inria, one of the three ERCIM founding institutes.

<http://fellowship.ercim.eu>



SCHLOSS DAGSTUHL
Leibniz-Zentrum für Informatik

Call for Proposals

Dagstuhl Seminars and Perspectives Workshops

Schloss Dagstuhl – Leibniz-Zentrum für Informatik is accepting proposals for scientific seminars/workshops in all areas of computer science, in particular also in connection with other fields.

If accepted the event will be hosted in the seclusion of Dagstuhl's well known, own, dedicated facilities in Wadern on the western fringe of Germany. Moreover, the Dagstuhl office will assume most of the organisational/administrative work, and the Dagstuhl scientific staff will support the organizers in preparing, running, and documenting the event. Thanks to subsidies the costs are very low for participants.

Dagstuhl events are typically proposed by a group of three to four outstanding researchers of different affiliations. This organizer team should represent a range of research communities and reflect Dagstuhl's international orientation. More information, in particular, details about event form and setup as well as the proposal form and the proposing process can be found on

<https://www.dagstuhl.de/dsproposal>

Schloss Dagstuhl – Leibniz-Zentrum für Informatik is funded by the German federal and state government. It pursues a mission of furthering world class research in computer science by facilitating communication and interaction between researchers.

Important Dates

- Proposal submission:
April 1 to April 15, 2020
- Notification: July 2020
- Seminar dates: Between March 2021 and February 2022 (tentative).

Tim Berners-Lee Launches Global Action Plan to Prevent "Digital Dystopia"

Tim Berners-Lee, together with leaders from government, business, civic groups and citizens from across the world, has launched the world's first-ever global action plan to halt the increasing misuse of the web and ensure it is protected as a force for good. The inventor of the web urged widespread backing of the plan, the Contract for the Web, which sets out concrete actions governments, companies and individual citizens can take to ensure a web that is safe, empowering and for everyone. The failure of global actors to defend the free and open web, he warned, risks a "digital dystopia" of entrenched inequality and abuse of rights.

The web has proved one of the most powerful tools we have to change lives for the better. However, its benefit to humanity is at risk due to a growing digital divide in access to the web and an increasing number of online threats, including election interference, online harassment, threats to privacy and the spread of disinformation. Tim Berners-Lee challenged governments and companies to show leadership in addressing the threats facing the web: "The Contract for the Web gives us a roadmap to build a better web. But it will not happen unless we all commit to the challenge. Governments need to strengthen laws and regulations for the digital age. Companies must do more to ensure pursuit of profit is not at the expense of human rights and democracy. And citizens must hold those in power accountable, demand their digital rights be respected and help foster healthy conversation online. It's up to all of us to fight for the web we want."

The Contract for the Web, led by Berners-Lee's World Wide Web Foundation, has been backed by over 150 organisations, thousands of individuals, hundreds of organisations and the governments of Germany, France and Ghana signed up to the Contract's founding principles.

Individuals and organisations are asked to endorse the Contract at:
<https://contractfortheweb.org/>



HORIZON 2020 Project Management

A European project can be a richly rewarding tool for pushing your research or innovation activities to the state-of-the-art and beyond. Through ERCIM, our member institutes have participated in more than 90 projects funded by the European Commission in the ICT domain, by carrying out joint research activities while the ERCIM Office successfully manages the complexity of the project administration, finances and outreach.

Horizon2020:Howcanyougetinvolved?

The ERCIM Office has recognized expertise in a full range of services, including:

- Identification of funding opportunities
- Recruitment of project partners (within ERCIM and through our networks)
- Proposal writing and project negotiation
- Contractual and consortium management
- Communications and systems support
- Organization of attractive events, from team meetings to large-scale workshops and conferences
- Support for the dissemination of results.

How does it work in practice?

Contact the ERCIM Office to present your project idea and a panel of experts within the ERCIM Science Task Group will review your idea and provide recommendations. Based on this feedback, the ERCIM Office will decide whether to commit to help producing your proposal. Note that having at least one ERCIM member involved is mandatory for the ERCIM Office to engage in a project. If the ERCIM Office expresses its interest to participate, it will assist the project consortium as described above, either as project coordinator or project partner.

Please contact:
Peter Kunz, ERCIM Office
peter.kunz@ercim.eu



W3Cx Introduction to Web Accessibility – New Online Course

The W3C and UNESCO Institute for Information Technologies in Education (IITE) have launched a new W3Cx course: Introduction to Web Accessibility. Designed for technical and non-technical audiences, including developers, designers, content authors, project managers, people with disabilities, and others, this course helps get a strong foundation in digital accessibility to make websites and apps work well for people with disabilities, meet international standards, and provide a better user experience for everyone. The course starts on 28 January 2020 and is self-paced. Read more in the course description and enroll soon!

This course is based on the open curricula of the W3C Web Accessibility Initiative (WAI), a framework for developing courses using role-based modules that build on and extend the Web Accessibility Initiative (WAI) accessibility training resources. These curricula are available to anyone to use as an authoritative foundation for creating courses, and are being developed through the consensus process of the W3C Education and Outreach Working Group (EOWG) with support from the European Commission (EC) funded WAI-Guide Project (Grant 822245).

<https://www.edx.org/course/web-accessibility-introduction>
<https://www.w3.org/WAI/curricula/>

HAL is Opening Up to Software

As a result of the collaboration between Software Heritage, HAL-Inria and the CCSD (Centre for Direct Scientific Communication), the open archive HAL is opening up to a new type of scientific data: software. Henceforth, researchers therefore have the possibility of depositing source code whilst contributing to the software heritage built up by Software Heritage. HAL is an open archive where authors can deposit scholarly documents from all academic fields.

<https://hal.archives-ouvertes.fr/>
<https://www.softwareheritage.org/>

David Chaum and Guido van Rossum awarded Dijkstra Fellowship

CWI has awarded David Chaum and Guido van Rossum for the first time the newly established honorary title ‘Dijkstra Fellow’. Chaum ‘forefather of blockchain’ is well known for his groundbreaking research in the area of Privacy and Cryptology and the development of digital currency. Van Rossum created the world-famous programming language Python almost 30 years ago, when he was working at CWI.

With the Dijkstra Fellowship CWI aims to recognize the impact of their groundbreaking work on mathematics and computer science. The Fellowship is also a recognition for the contribution they made to CWI’s reputation as a pioneer in the area of Mathematics and Computer Science. The honorary title is named after former CWI researcher Edsger W. Dijkstra, who was one of the most influential scientists in the history of CWI by - next to other accomplishments - developing the shortest path algorithm.



Photo: CWI/Hoge Hoogland

Guido van Rossum (left) is awarded with the Dijkstra Fellowship for the impact of his programming language Python. Python is currently one of the most used programming languages in the world. Python is highly used for programming applications in the field of AI. The language is available open source and has a globally active user community.

David Chaum (right), mathematician and computer scientist receives the honorary title “Dijkstra Fellow” for his advanced research in the area of Privacy and Cryptology. By setting up the Cryptology research group at CWI in the early 80’s, he brought modern cryptology to Europe. He is internationally recognized as the founder of digital currencies and blockchain technology. Spin-off DigiCash emerged from his research work. Chaum developed eCash, the precursor of the bitcoin, under the flag of DigiCash.

<https://www.cwi.nl/news/blogs/interview-david-chaum-201cblockchain-will-decentralize-power201d>

<https://www.cwi.nl/news/blogs/interview-guido-van-rossum-201cid-rather-write-code-than-papers.201d>



ERCIM is the European Host of the World Wide Web Consortium.



Consiglio Nazionale delle Ricerche
Area della Ricerca CNR di Pisa
Via G. Moruzzi 1, 56124 Pisa, Italy
www.iit.cnr.it



Norwegian University of Science and Technology
Faculty of Information Technology, Mathematics and Electrical Engineering, N 7491 Trondheim, Norway
<http://www.ntnu.no/>



Centrum Wiskunde & Informatica

Centrum Wiskunde & Informatica
Science Park 123,
NL-1098 XG Amsterdam, The Netherlands
www.cwi.nl



RISE SICS
Box 1263,
SE-164 29 Kista, Sweden
<http://www.sics.se/>



Fonds National de la
Recherche Luxembourg

Fonds National de la Recherche
6, rue Antoine de Saint-Exupéry, B.P. 1777
L-1017 Luxembourg-Kirchberg
www.fnrl.lu



SBA Research gGmbH
Floragasse 7, 1040 Wien, Austria
www.sba-research.org/



Foundation for Research and Technology – Hellas
Institute of Computer Science
P.O. Box 1385, GR-71110 Heraklion, Crete, Greece
www.ics.forth.gr



SIMULA
PO Box 134
1325 Lysaker, Norway
www.simula.no



Magyar Tudományos Akadémia
Számítástechnikai és Automatizálási Kutató Intézet
P.O. Box 63, H-1518 Budapest, Hungary
www.sztaki.hu/



Fraunhofer ICT Group
Anna-Louisa-Karsch-Str. 2
10178 Berlin, Germany
www.iuk.fraunhofer.de



TNO
PO Box 96829
2509 JE DEN HAAG
www.tno.nl



INESC
c/o INESC Porto, Campus da FEUP,
Rua Dr. Roberto Frias, n° 378,
4200-465 Porto, Portugal
www.inesc.pt



University of Cyprus
P.O. Box 20537
1678 Nicosia, Cyprus
www.cs.ucy.ac.cy/



Institut National de Recherche en Informatique
et en Automatique
B.P. 105, F-78153 Le Chesnay, France
www.inria.fr



University of Warsaw
Faculty of Mathematics, Informatics and Mechanics
Banacha 2, 02-097 Warsaw, Poland
www.mimuw.edu.pl/



I.S.I. – Industrial Systems Institute
Patras Science Park building
Platani, Patras, Greece, GR-26504
www.isi.gr



VTT Technical Research Centre of Finland Ltd
PO Box 1000
FIN-02044 VTT, Finland
www.vttresearch.com

Figure 1: